



THE DISPLAY CHOICE  
OF PROFESSIONALS™

TXA2401 Medical Panel PC

# User Manual

[www.agneovo.com](http://www.agneovo.com)

# TABLE OF CONTENTS

|  |           |
|--|-----------|
| <b>SAFETY INFORMATION .....</b>            | <b>3</b>  |
| <b>PRECAUTIONS .....</b>                   | <b>8</b>  |
| <b>CHAPTER 1: PRODUCT DESCRIPTION.....</b> | <b>12</b> |
| 1.1 Package Contents.....                  | 12        |
| 1.2 Wall Mounting.....                     | 13        |
| 1.3 LCD Monitor Overview .....             | 14        |
| 1.3.1 Front & Side View .....              | 14        |
| 1.3.2 Rear & Bottom View.....              | 15        |
| 1.3.3 Input/Output View.....               | 16        |
| 1.4 Basic Operation.....                   | 17        |
| 1.4.1 Powering ON &OFF .....               | 17        |
| 1.4.2 Charging the Battery .....           | 18        |
| 1.4.3 Battery Level Indication.....        | 18        |
| 1.5 System Assembly.....                   | 19        |
| 1.5.1 Opening the Cable Cover .....        | 19        |
| 1.5.2 Replacing the Battery.....           | 19        |
| 1.5.3 Replacing the HDD .....              | 19        |
| 1.5.4 Installing the Cable Cover.....      | 20        |
| <b>CHAPTER 2: BIOS Setup .....</b>         | <b>21</b> |
| 2.1 About BIOS Setup.....                  | 21        |
| 2.1.1 When to Use BIOS Setup? .....        | 21        |
| 2.1.2 How to run BIOS Setup ?.....         | 21        |
| <b>CHAPTER 3: APPENDIX.....</b>            | <b>22</b> |
| 3.1 Cleaning .....                         | 22        |
| 3.2 Troubleshooting.....                   | 23        |
| <b>CHAPTER 4: SPECIFICATIONS .....</b>     | <b>24</b> |
| 4.1 Specification.....                     | 24        |
| 4.2 Monitor Dimensions .....               | 25        |

# SAFETY INFORMATION

- 1) To disconnect the machine from the electrical power supply, turn off the power switch and remove the power cord plug from the wall socket. The wall socket must be easily accessible and in close proximity to the machine.
- 2) Read these instructions carefully. Save these instructions for future reference.
- 3) Follow all warnings and instructions marked on the product.
- 4) Do not use this product near water.
- 5) Do not place this product on an unstable cart, stand, or table. The product may fall, causing serious damage to the product.
- 6) Slots and openings in the cabinet and the back or bottom are provided for ventilation to ensure reliable operation of the product and to protect it from overheating. These openings must not be blocked or covered. The openings should never be blocked by placing the product on a bed, sofa, rug, or other similar surface. This product should never be placed near or over a radiator or heat register or in a built-in installation unless proper ventilation is provided.
- 7) This product should be operated from the type of power indicated on the marking label. If you are not sure of the type of power available, consult your dealer or local power company.
- 8) Do not allow anything to rest on the power cord. Do not locate this product where persons will walk on the cord.
- 9) Never push objects of any kind into this product through cabinet slots as they may touch dangerous voltage points or short out parts that could result in a fire or electric shock. Never spill liquid of any kind on the product.
- 10) To avoid the risk of electric shock, this equipment must only be connected to a supply mains with protective earth.
- 11) No modification of this equipment is allowed.
- 12) Power supply is specified as part of medical equipment.
- 13) The medical PC can be cleaned in accordance with normal clinical cleaning practices, including wiping with water or medical grade wipes, provided no substance containing acids or cleaning alkali liquids is used.
- 14) Medical grade wipes must not contain more than 75% alcohol content measured against the total content of the wipe.
- 15) Operator shall not contact patient simultaneously when in use with the medical computer.
- 16) USB Power Distribution Limitation

The USB ports of this equipment are powered by the internal power system and share a limited total current output.

The total current consumption of all connected USB devices shall not exceed the specified system limits.

Connecting multiple high-power USB devices simultaneously may result in temporary port shutdown, device malfunction, or system instability.

The use of self-powered USB devices or externally powered USB hubs is recommended where

# SAFETY INFORMATION

applicable.

## Regulatory Compliance (LPS)

To comply with applicable safety standards for Limited Power Source (LPS) requirements (IEC 60950-1/IEC 62368-1), the total load connected to the USB interfaces shall remain within the specified system power limits.

## USB Electrical Characteristics

- Maximum current per USB port: 1.0 A
- Total USB current limit (all ports combined): 4.0 A

## Protection Mechanism

The system provides overcurrent protection (OCP). In the event of an overload condition, USB ports may shut down automatically and resume operation once normal conditions are restored.

## 17) WARNING

To prevent injury caused by falling equipment, this product shall be securely mounted by qualified personnel using approved mounting hardware.

The installation height shall not exceed 2 m above floor level.

# SAFETY INFORMATION



This device complies with the requirements of the EEC directive 2014/30/EU with regard to “Electromagnetic compatibility” and 2014/35/EU “Low Voltage Directive”.

| EU legislation                                       | UK legislation                                 |
|--|--|
| Electromagnetic Compatibility - Directive 2014/30/EU | Electromagnetic Compatibility Regulations 2016 |
| Low Voltage Directive 2014/35                        | Electrical Equipment (Safety) Regulations 2016 |
| Radio equipment - Directive 2014/53/EU               | Radio Equipment Regulations 2017               |

## CAUTION ON LITHIUM BATTERIES

There is a danger of explosion if the battery is replaced incorrectly. Replace only with the same or equivalent type recommended by the manufacturer. Discard used batteries according to the manufacturer’s instructions.



### Battery Caution

Risk of explosion if battery is replaced by an incorrectly type. Dispose of used battery according to the local disposal instructions.



### Safety Caution

Note: To comply with IEC60950-1 Clause 2.5 (limited power sources, L.P.S) related legislation, peripherals shall be 4.7.3.2 “Materials for fire enclosure” compliant.

# SAFETY INFORMATION

## 4.7.3.2 Materials for fire enclosures

For MOVABLE EQUIPMENT having a total mass not exceeding 18kg.the material of a FIRE ENCLOSURE, in the thinnest significant wall thickness used, shall be of V-1CLASS MATERIAL or shall pass the test of Clause A.2.

For MOVABLE EQUIPMENT having a total mass exceeding 18kg and for all STATIONARY EQUIPMENT, the material of a FIRE ENCLOSURE, in the thinnest significant wall thickness used, shall be of 5VB CLASS MATERIAL or shall pass the test of ClauseA.1

## AVERTISSEMENT SUR LES BATTERIES AU LITHIUM

Il y a un danger d'explosion si la batterie n'est pas remplacée correctement. Remplacez-la uniquement par une batterie identique ou de type équivalent recommandée par le fabricant.les batteries usagées doivent être mises au rebut conformément aux instructions du fabricant.



### Avertissement Batterie

Risque d'explosion si la batterie est remplacée par un élément incompatible.  
Jetez les batteries usagées selon les instructions des dispositions locales.



### Avertissement de sécurité

Remarque: Pour répondre à la norme IEC60950-1 alinéa 2.5 (sources d'énergie limitées, LPS) liés la législation, les périphériques doivent être conforme 4.7.3.2 « Matériaux pour enceinte coupe-feu »

#### 4.7.3.2 « Matériaux pour équipements coupe-feu »

Pour les équipements mobiles ayant une masse totale n'excédant pas 18kg :  
Les matériaux d'un équipement coupe-feu, dans l'épaisseur de paroi retenue la plus significativement mince, doivent être des matériels de CLASSE V-1 ou doivent passer le test de l'article A.2.

Pour équipements mobiles ayant une masse totale supérieure à 18 kg et pour tous les équipements FIXES :

Les matériaux d'un équipement coupe-feu dans l'épaisseur de paroi retenue la plus significativement mince, doivent être des matériels de CLASSE V-1, doivent être de classe Matériel 5VB ou doivent passer le test de l'article A.1

# SAFETY INFORMATION

## WEEE

Disposal of Waste Equipment by Users in Private Household in the European Union.

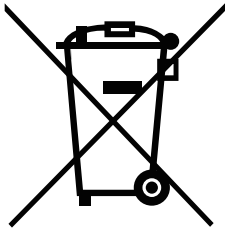

This symbol on the product or on its packaging indicates that this product must not be disposed of with your other household waste. Instead, it is your responsibility to dispose of your waste equipment by handing it over to a designated collection point for the recycling of waste electrical and electronic equipment. The separate collection and recycling of your waste equipment at the time of disposal will help to conserve natural resources and ensure that it is recycled in a manner that protects human health and the environment. For more information about where you can drop off your waste equipment for recycling, please contact your local city office, your household waste disposal service or the shop where you purchased the product

For Private Households in the European Union. To help conserve natural resources and ensure the product is recycled in a manner that protects human health and the environment, we would like to bring your attention to the following:

- The crossed-out dustbin on the device or outer packaging indicates the product is compliant with European WEEE (Waste Electrical and Electronic Equipment) Directive
- Always dispose of the old devices separately from household waste
- Batteries should be removed beforehand and disposed separately to the right collection system
- You are responsible with regard to the deletion of personal data on old devices before disposal
- Private households can hand in their old devices free of charge
- For more information about where you can drop off your waste equipment for recycling, please contact your local city office, your household waste disposal service or the shop where you purchased the product

# SAFETY INFORMATION











## IEC standards

Accessory equipment connected to the analog and digital interfaces must be in compliance with the respective nationally harmonized IEC standards (i.e. IEC 60950 for data processing equipment, IEC 60065 for video equipment, IEC 61010-1 for laboratory equipment, and IEC 60601-1 for medical equipment.)

Furthermore, all configurations shall comply with the system standard IEC 60601-1. Anyone who connects additional equipment to the signal input part or signal output part is configuring a medical system, and is therefore, responsible that the system complies with the requirements of the system standard IEC 60601-1.

The unit is for exclusive interconnection with IEC 60601-1 certified equipment in the patient environment and IEC 60XXX certified equipment outside of the patient environment. If in doubt, consult the technical services department or your local representative.

## Symbol Definition

| Symbol  | Definition                               | Symbol  | Definition                               |
|---|--|---|--|
|  | ISO 7010 - M002:<br>Instructions for use |  | IEC 60417 - 5032:<br>Alternating Current |
|  | ISO 15223-1: 2021:<br>Medical Device     |  | ISO 7000 – 2497:<br>Data of manufacture  |
|  | IEC 60417 - 5009: STAND-BY               |  | IEC 60417 - 5031: Direct Current         |
|  | Handle with care                         |  | Fragile                                  |
|  | Keep away from rain                      |  | This side up                             |



Consult instructions for use or consult electronic instructions for use

# PRECAUTIONS

## PRECAUTIONS

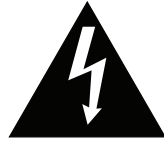

**CAUTION**  
RISK OF ELECTRIC SHOCK  
DO NOT OPEN



### Symbols used in this manual



This icon indicates the existence of a potential hazard that could result in personal injury or damage to the product.



This icon indicates important operating and servicing information.

## Notice

- Read this User Manual carefully before using the LCD monitor and keep it for future reference.
- The product specifications and other information provided in this User Manual are for reference only. All information is subject to change without notice. Updated content can be downloaded from our web site at [www.agneovo.com](http://www.agneovo.com).
- To protect your rights as a consumer, do not remove any stickers from the LCD monitor. Doing so may affect the determination of the warranty period.

## Cautions When Setting Up



Do not place the LCD monitor near heat sources, such as a heater, exhaust vent, or in direct sunlight.



Do not cover or block the ventilation holes in the housing.



Place the LCD monitor on a stable area. Do not place the LCD monitor where it may be subject to vibration or shock.



Place the LCD monitor in a well-ventilated area.



Do not place the LCD monitor outdoors.



Do not place the LCD monitor in a dusty or humid environment.



Do not spill liquid or insert sharp objects into the LCD monitor through the ventilation holes. Doing so may cause accidental fire, electric shock or damage the LCD monitor.

# PRECAUTIONS

## Cautions When Using



Use only the power cord supplied with the LCD monitor.



The power outlet should be installed near the LCD monitor and be easily accessible.



If an extension cord is used with the LCD monitor, ensure that the total current consumption plugged into the power outlet does not exceed the ampere rating.



Do not allow anything to rest on the power cord. Do not place the LCD monitor where the power cord may be stepped on.



If the LCD monitor will not be used for an indefinite period of time, unplug the power cord from the power outlet.



To disconnect the power cord, grasp and pull by the plug head. Do not tug on the cord; doing so may cause fire or electric shock.



Do not unplug or touch the power cord with wet hands.



### WARNING:

Unplug the power cord from the power outlet and refer to qualified service personnel under the following conditions:



- When the power cord is damaged.
- If the LCD monitor has been dropped or the housing has been damaged.
- If the LCD monitor emits smoke or a distinct odor.



Ceiling mount or mount on any other horizontal surface overhead are not advisable.



### WARNING:

Installation in contravention of the instructions may result in undesirable consequences, particularly hurting people and damaging property. Users who have already mounted the monitor on the ceiling or any other horizontal surface overhead are strongly advised to contact AG Neovo for consultations and solutions to help ensure a most pleasurable and fulfilling monitor experience.



### Thermal & VESA Mounting Guide

This fanless product dissipates heat through the VESA mounting area and rear metal plate. A metal VESA mount is highly recommended to optimize cooling.



### CAUTION:

The VESA area can reach high temperatures during operation. Avoid touching to prevent burns.

# PRECAUTIONS

---

## Cleaning and Maintenance

---



Do not attempt to service the LCD monitor yourself, refer to qualified service personnel.

Opening or removing the covers may expose you to dangerous voltage or other risks.

---

---

## Notice for the LCD Monitor

---

In order to maintain the stable luminous performance, it is recommended to use low brightness setting.

Due to the lifespan of the lamp, it is normal that the brightness quality of the LCD monitor may decrease with time.

When static images are displayed for long periods of time, the image may cause an imprint on the LCD monitor. This is called image retention or burn-in.

To prevent image retention, do any of the following:

- Set the LCD monitor to turn off after a few minutes of being idle.
- Use a screen saver that has moving graphics or a blank white image.
- Switch desktop backgrounds regularly.
- Adjust the LCD monitor to low brightness settings.
- Turn off the LCD monitor when the system is not in use.

Things to do when the LCD monitor shows image retention:

- Turn off the LCD monitor for extended periods of time. It can be several hours or several days.
  - Use a screen saver and run it for extended periods of time.
  - Use a black and white image and run it for extended periods of time.
- 

There are millions of micro transistors inside the LCD monitor. It is normal for a few transistors to be damaged and to produce spots. This is acceptable and is not considered a failure.

---

# CHAPTER 1: PRODUCT DESCRIPTION

## 1.1 Package Contents

### A. Medical Panel PC



### B. Cable Cover Screws (M3\*6 x 2)



### C. Power adapter

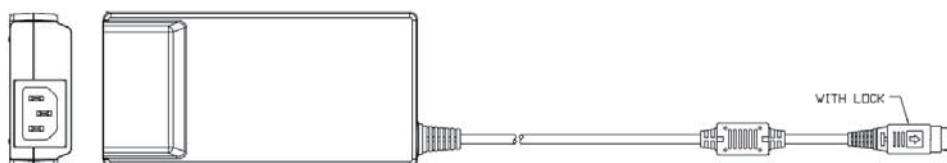

### D. Power cord

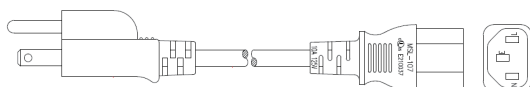

### E. Battery (Optional)

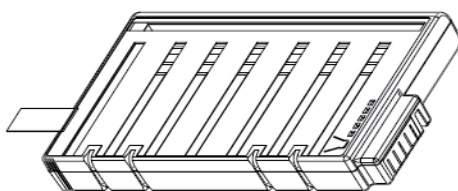

#### Note:

1. Power cord will be supplied differently according to various region or country.

2. Must use only the supplied power adapter:

◆ FSP Group Inc.

Model no.: FSP090M-RBA

3. Device. Battery Manufacturer:

◆ Japone Technology Inc.

Model no.: DR-202-GA

- It is suggested to charge the battery every 3 months if it is not used.

# PRODUCT DESCRIPTION

## 1.2 Wall Mounting

To wall-mount the LCD monitor, screw the mounting bracket to the VESA holes at the rear of the LCD monitor.

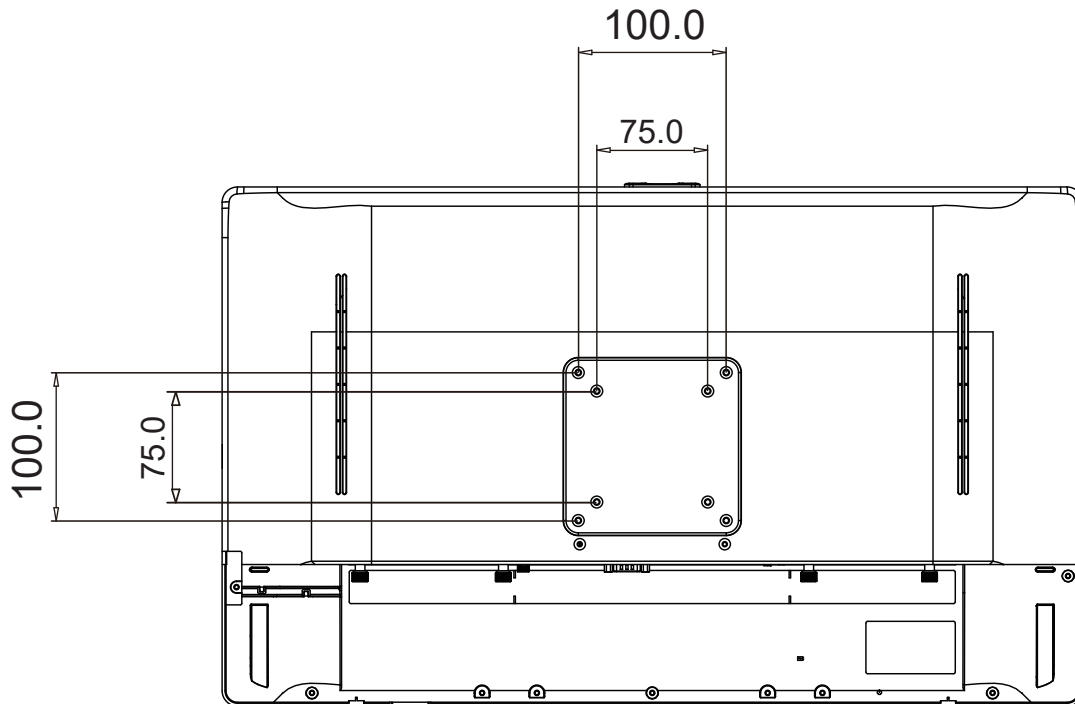

**Note:** Take measures to prevent the LCD monitor from falling down and lessen possible injury and damage to the monitor in case of earthquakes or other disasters.

- Use only the 75 x 75 mm and 100 x 100 mm wall mount kit recommended by AG Neovo.
- Secure the LCD monitor on a solid wall strong enough to bear its weight.
- It is suggested to wall mount the LCD monitor without tilting it facing downward.

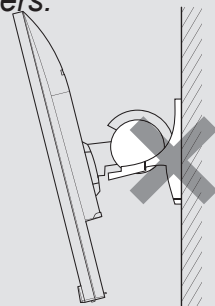

# PRODUCT DESCRIPTION

## 1.3 LCD Monitor Overview

### 1.3.1 Front & Side View

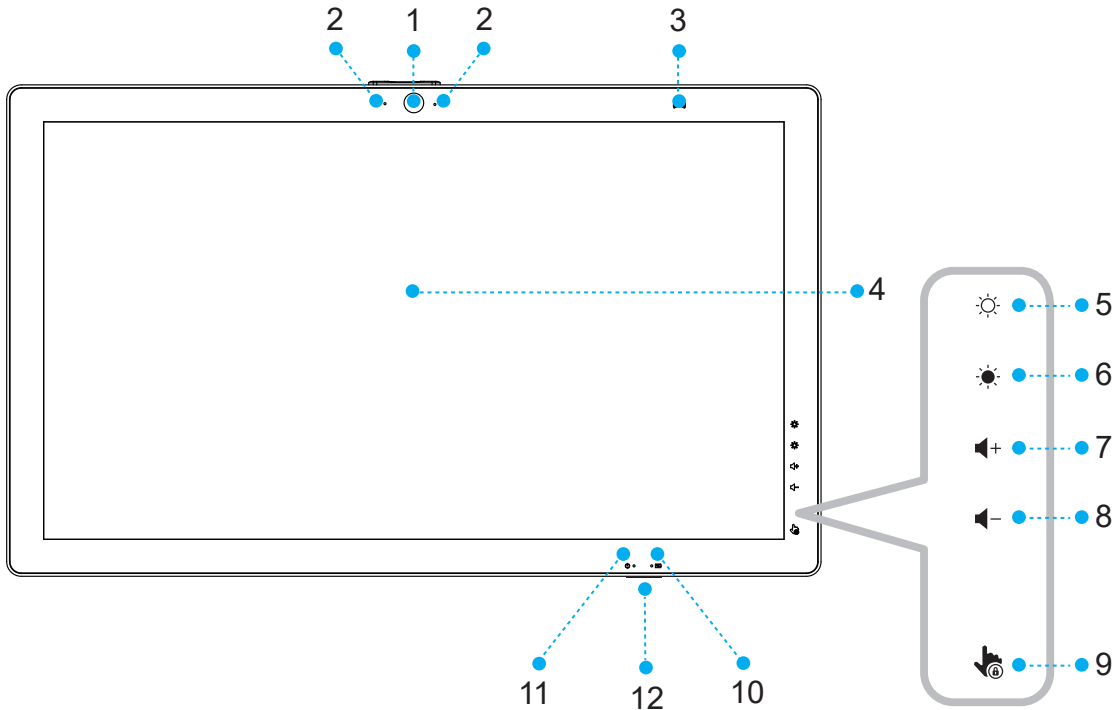

| Item No. | Description  |
|----------|--|
| 1        | Front Camera (5M)  |
| 2        | Microphone x2  |
| 3        | RFID (No support)  |
| 4        | 23.8" true flat PCAP multi-touch   |
| 5        | Brightness Increases   |
| 6        | Brightness Decreases   |
| 7        | Volume Increases   |
| 8        | Volume Decreases   |
| 9        | Touch Lock<br><b>Note:</b> <ul style="list-style-type: none"><li>• <i>Locking: Press and hold for 5 seconds.</i></li><li>• <i>Unlocking: Touch function will be restored automatically after 30 seconds.</i></li></ul> |
| 10       | Amber LED Indicator Light : Battery status   |
| 11       | Blue LED Indicator Light : Power status  |
| 12       | Power button   |

# PRODUCT DESCRIPTION

## 1.3.2 Rear & Bottom View

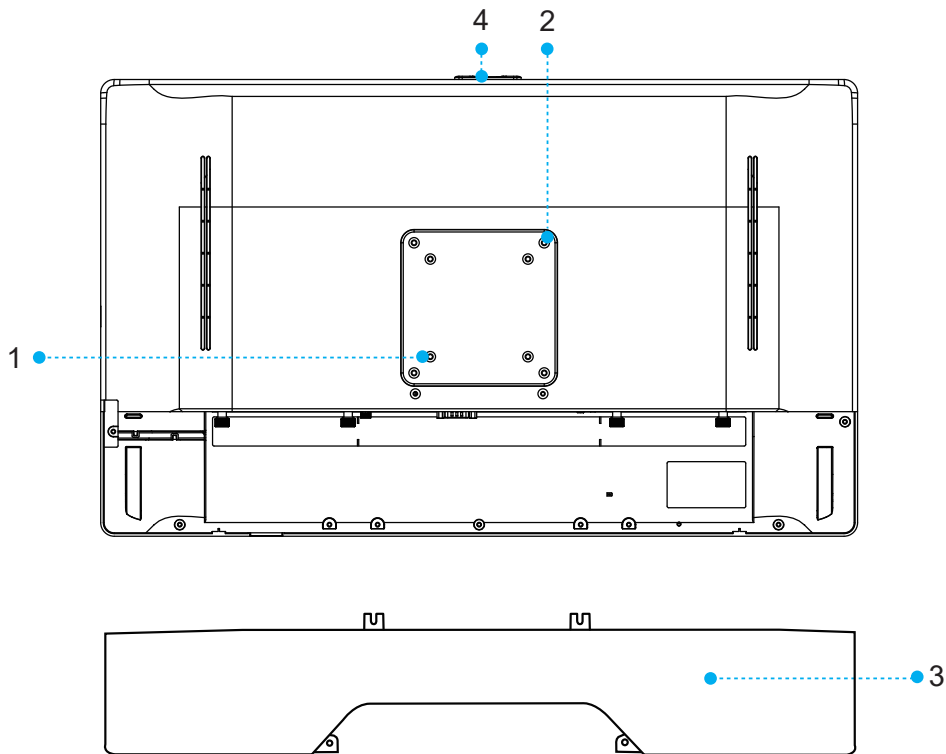

| Item No. | Description                   |
|----------|-------------------------------|
| 1        | 75 x 75 VESA mounting holes   |
| 2        | 100 x 100 VESA mounting holes |
| 3        | Cable Cover                   |
| 4        | Camera Privacy Latch          |

### Note:

1. This product does not include a wall mount bracket or mounting screws. Please purchase these separately if wall mounting is required.
2. Wall mount screws are M4 size, 6mm deep (Max). Please ensure that the screws meet the specifications to ensure a secure installation.

# PRODUCT DESCRIPTION

## 1.3.3 Input/Output View

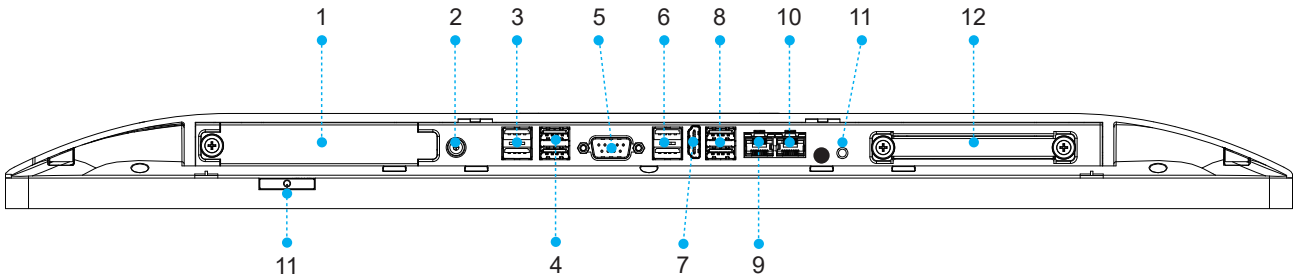

| Item No. | Description                       |
|----------|-----------------------------------|
| 1        | Battery Cover / Battery slot      |
| 2        | DC input                          |
| 3        | USB 2.0 (x2)                      |
| 4        | USB 3.0 (x2)                      |
| 5        | Serial port 1 (COM1)              |
| 6        | USB 2.0 (x2)                      |
| 7        | HDMI OUT 1.4 (x1)                 |
| 8        | USB 3.0 (x2)                      |
| 9        | LAN 2                             |
| 10       | LAN 1                             |
| 11       | Power button                      |
| 12       | HDD/SSD Cover / 2.5" HDD/SSD Slot |

### Note:

#### USB Power Characteristics:

- Maximum current per USB port: 1.0A
- Total USB current limit (all ports combined): 4.0A
- Total USB power budget: 20 W (5V DC)

#### Notice:

The total USB load shall not exceed the specified limits in order to maintain compliance with LPS (Limited Power Source) requirements.

# PRODUCT DESCRIPTION

## 1.4 Basic Operation

### 1.4.1 Powering ON & OFF

To activate the system, push and quickly release the power button and the display will come on in a few seconds.

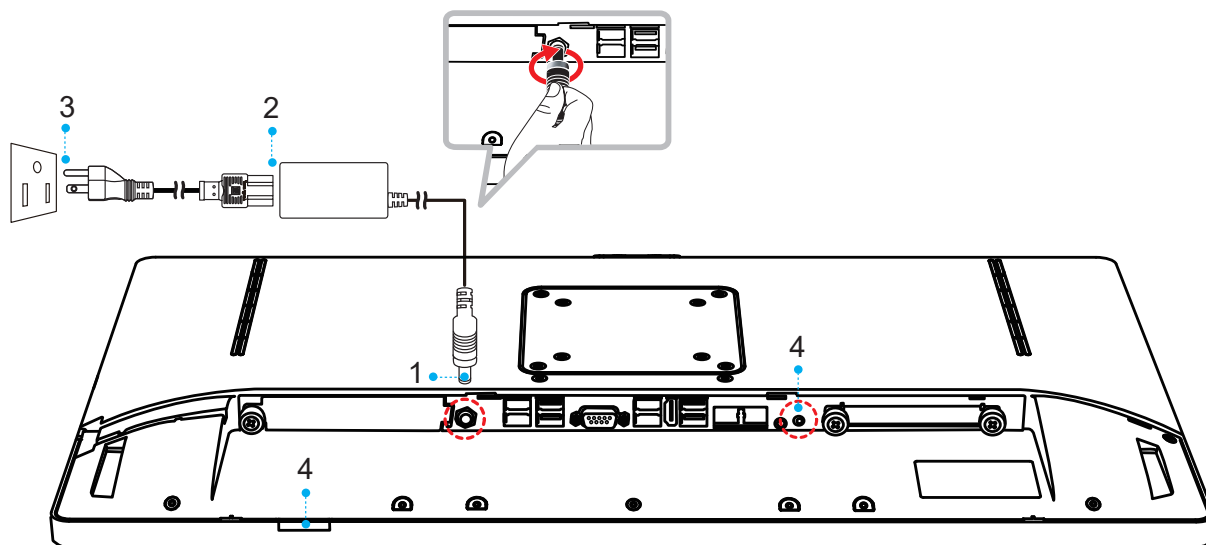

Follow the steps (1-3) below to connect the AC adapter to the power jack (DC-IN). Press the power switch/button (4) to turn on the system.

#### Note:

The system must be plugged into power adapter or battery charged before turning on for the first time.

To turn off the system, power off the device safely using software “function that “shuts down computer” provide in the operating system.

# PRODUCT DESCRIPTION

## 1.4.2 Charging the Battery

System with hot-swappable battery.

1. The batteries may be charged by connecting the supplied power adapter directly to the DC-in port on the system.
2. Open the cable cover and plug the cable directly into the connector. Then plug the adapter directly into the power outlet.
3. Status will show the capacity of each battery.

### DC in Mode: Battery Charged Battery Mode



## 1.4.3 Battery Level Indication

Each battery provides a battery level indicator LED on the front of the system. The signal charge status are as follows:

### LED\_1 (blue light) Power Status:

- Power Off (no light)
- Power\_LED (constant light)
- Standby LED (flashing)

### LED\_2 (orange light) Battery Status:

- No battery installed or fully charged. (no light)
- Charging (constant light)
- Low battery voltage (flashing)

## 1.5 System Assembly

### 1.5.1 Opening the Cable Cover

1. Place the system face down, make sure not to scratch the screen.
2. Press and pull the cable cover outwards to release it from the system.

### 1.5.2 Replacing the Battery

1. Place the system face down, make sure not to scratch the screen.



### 1.5.3 Replacing the HDD/SSD

1. The system does not support hot-plug hard drives.
2. Place the system face down, make sure not to scratch the screen.

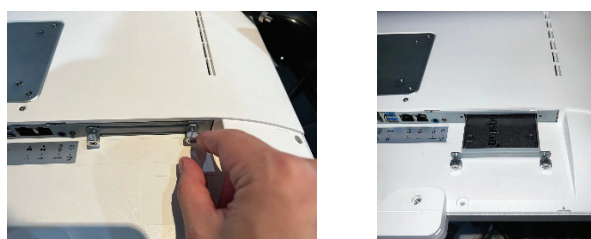

#### Operation Caution

We recommend that contacting your service contract to assemble and remove such parts.

# PRODUCT DESCRIPTION

## 1.5.4 Installing the Cable Cover

1. Align and install the cover: Align the cable cover with the slots on the back of the system. Hold both sides of the cover with your hands and push it inward following the direction of the arrows until it clicks into place.

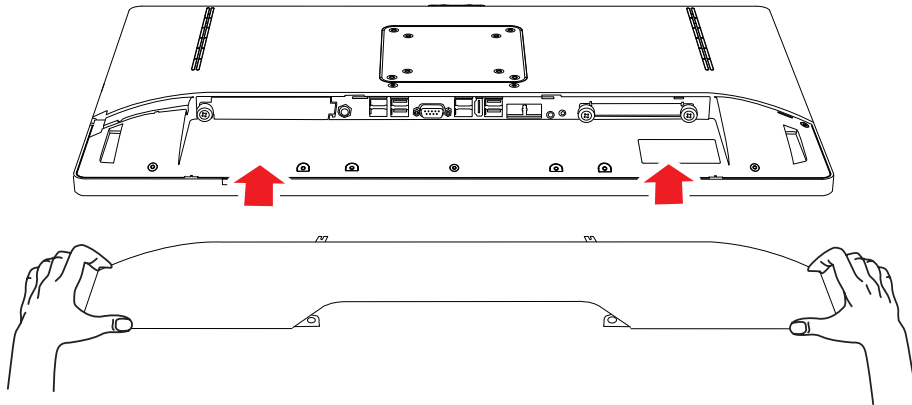

2. Secure the screws: Using a screwdriver, tighten the two screws clockwise into the designated holes on the cable cover to ensure it is securely fastened.

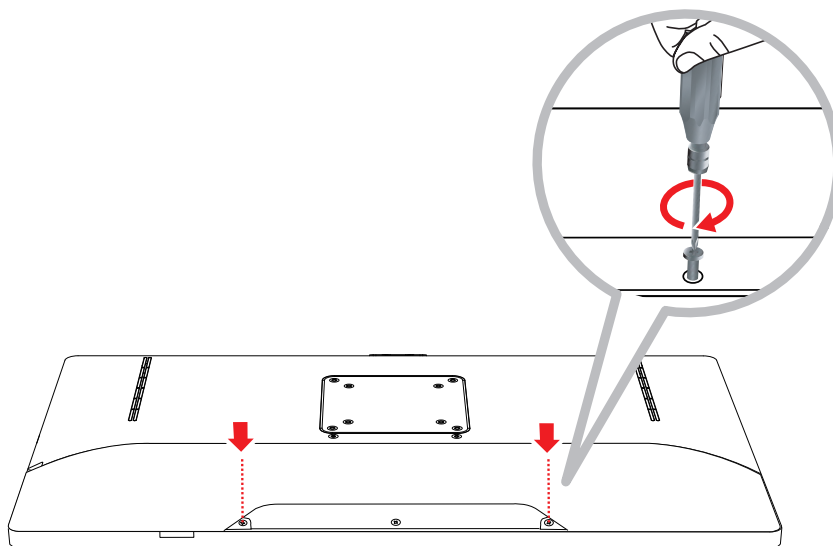

### Note:

Two cable cover screws (SPEC: M3\*6 x2) are included and can be found in the screw pack.

# CHAPTER 2: BIOS Setup

## 2.1 About BIOS Setup

The default BIOS (Basic Input/Output System) is already properly configured and optimized, there is normally no need to run this utility.

### 2.1.1 When to Use BIOS Setup?

You may need to run the BIOS Setup when:

- An error message appears on the screen during the system booting up and is requested to run SETUP.
- You want to change the default settings for customized features.
- You want to reload the default BIOS settings.



#### **CAUTION!**

We strongly recommend that you change the BIOS settings only with the help of a trained service personnel.

### 2.1.2 How to run BIOS Setup?

To run the BIOS Setup Utility, turn on the panel PC and press the [Del] key during the POST procedure.

If the message disappears before you respond and you still wish to enter Setup, either restart the system by turning it OFF and ON, or simultaneously pressing [Ctrl]+[Alt]+[Del] keys to restart.

The setup function only can be invoked by pressing [Del] key during POST that provide an approach to change some setting and configuration the user prefer, and the changed values will save in the NVRAM and will take effect after the system rebooted.

## 3.1 Cleaning

### Front Panel Cleaning Instructions

- The front of the monitor has been specially treated. Wipe the surface gently using only a cleaning cloth or a soft, lint-free cloth.
- If the surface becomes dirty, soak a soft, lint-free cloth in a mild detergent solution. Wring the cloth to remove excess liquid. Wipe the surface of the monitor to remove dirt. Then use a dry cloth of the same type to dry.
- Do not use volatile substances such as insect sprays, solvents and thinners.

### Cabinet Cleaning Instructions

- If the cabinet becomes dirty, wipe the cabinet with a soft, dry cloth.
- If the cabinet is extremely dirty, soak a lint-free cloth in a mild detergent solution. Wring the cloth to remove as much moisture as possible. Wipe the cabinet. Use another dry cloth to wipe over until the surface is dry.
- Do not allow any water or detergent to come into contact with the surface of the monitor. If water or moisture gets inside the unit, operating problems, electrical and shock hazards may result.
- Do not scratch or hit the cabinet with fingers or hard objects of any kind.
- Do not use volatile substances such as insect sprays, solvents and thinners on the cabinet.
- Do not place anything made from rubber or PVC near the cabinet for any extended periods of time.

## 3.2 Troubleshooting

For your own safety and that of your equipment, always take the following precautions.

Disconnect the power plug (by pulling the plug, not the cord), from your computer if any of the following conditions exists:

- 1) You suspect that your computer needs service or repair.
- 2) You want to clean the computer or screen.
- 3) Your computer has been dropped or damaged.
- 4) The power cord or plug becomes frayed or otherwise damaged.
- 5) You spill something into the system.

Repair of the device may only be carried out by the manufacture.

We that a service contract be obtained with supplier and that all repairs also be carried out by them. Otherwise the correct functioning of the device may be compromised.

- 1) Please use suitable mounting apparatus to avoid risk of injury. It shall be mounted by trained and authorized personnel on adequate allowances for quality of materials used to make the connection.
- 2) In case of serious incident that has occurred, please contact the manufacturer and local authorities immediately.
- 3) To prevent unauthorized access, it is recommended to install suitable anti-virus software or do not connect to unsafe external networks.
- 4) It is recommended to install the appropriate software, if have any question, please contact the manufacturer for further assistance.

# CHAPTER 4: SPECIFICATIONS

## 4.1 Specification

|                           |                              | TXA2401  |
|---------------------------|------------------------------|--|
| Panel                     | Panel Type                   | LED-Backlit TFT LCD (VA Technology)  |
|                           | Panel Size                   | 23.8"  |
|                           | Max. Resolution              | FHD 1920 x 1080  |
|                           | Pixel Pitch                  | 0.274 mm   |
|                           | Brightness                   | 250 cd/m <sup>2</sup>  |
|                           | Contrast Ratio               | 3000:1   |
|                           | Viewing Angle (H/V)          | 178°/178°  |
|                           | Display Colour               | 16.7M  |
|                           | Response Time                | 5 ms   |
| Output                    | HDMI                         | 1.4 x 1  |
| External Control          | Serial/COM                   | COM x 1  |
|                           | LAN                          | RJ45 x 2   |
| Wireless                  | Wi-Fi/Bluetooth              | Wi-Fi 802.11 a/b/g/n/ac/ax, Bluetooth 5.2  |
| Embedded Player           | OS                           | Windows 11 IoT Enterprise 64bit  |
|                           | CPU                          | Intel Core i5-1135-G7  |
|                           | Memory                       | 8GB DDR4 (default), support up to 32GB   |
|                           | Storage                      | 2.5" SATA SSD 256GB (default), support up to 1TB;<br>SATA M.2 2280 SSD 64GB–1TB (Optional) |
| Other Connectivity        | USB                          | 2.0 x 4, 3.0 x 4   |
| Audio                     | Internal Speakers            | 3W x 2   |
| Touch Screen              | Technology                   | Projective Capacitive  |
|                           | Positional Accuracy          | ±1.5mm (90% area)  |
|                           | Panel Interface              | USB 2.0 x1   |
|                           | Multi-touch Plug & Play      | 10-point touch   |
| Camera                    | Resolution                   | 5MP  |
|                           | Pixel                        | 1.4µm x 1.4µm  |
|                           | Microphone                   | x 2  |
| Power                     | Battery                      | DR-202-GA (Optional)   |
|                           | Power Supply                 | External   |
|                           | Power Requirements           | DC 19V, 4.74A  |
|                           | On Mode                      | 75W (Max)  |
| Glass                     | Surface Treatment            | Clear Glass  |
|                           | Thickness                    | 2.4 mm   |
|                           | MOHS Hardness                | 5  |
|                           | IK Rating                    | IK05   |
| Durability and Protection | IP Rating                    | Front-Sided IP65   |
| Operating Conditions      | Temperature                  | 0°C-40°C (32°F-104°F)  |
|                           | Humidity                     | 10%-90% (non-condensing)   |
| Storage Conditions        | Temperature                  | -20°C - 60°C (-4°F-144°F)  |
|                           | Humidity                     | 10%-90% (non-condensing)   |
| Mounting                  | VESA FPMPMI                  | Yes (75 x 75 mm, 100 x 100 mm)   |
| Dimensions                | Product w/o Base (W x H x D) | 581.4 x 353.4 x 43.1 mm (22.9" x 13.9" x 1.7")   |
|                           | Packaging (W x H x D)        | 648.0 x 520.0 x 164.0 mm (25.5" x 20.5" x 6.5")  |
| Weight                    | Product w/o Base             | 6.8 kg (15.0 lbs)  |
|                           | Packaging                    | 9.6 kg (21.2 lbs)  |

### Note:

- ◆ All specifications are subject to change without prior notice.

# SPECIFICATIONS

## 4.2 Monitor Dimensions

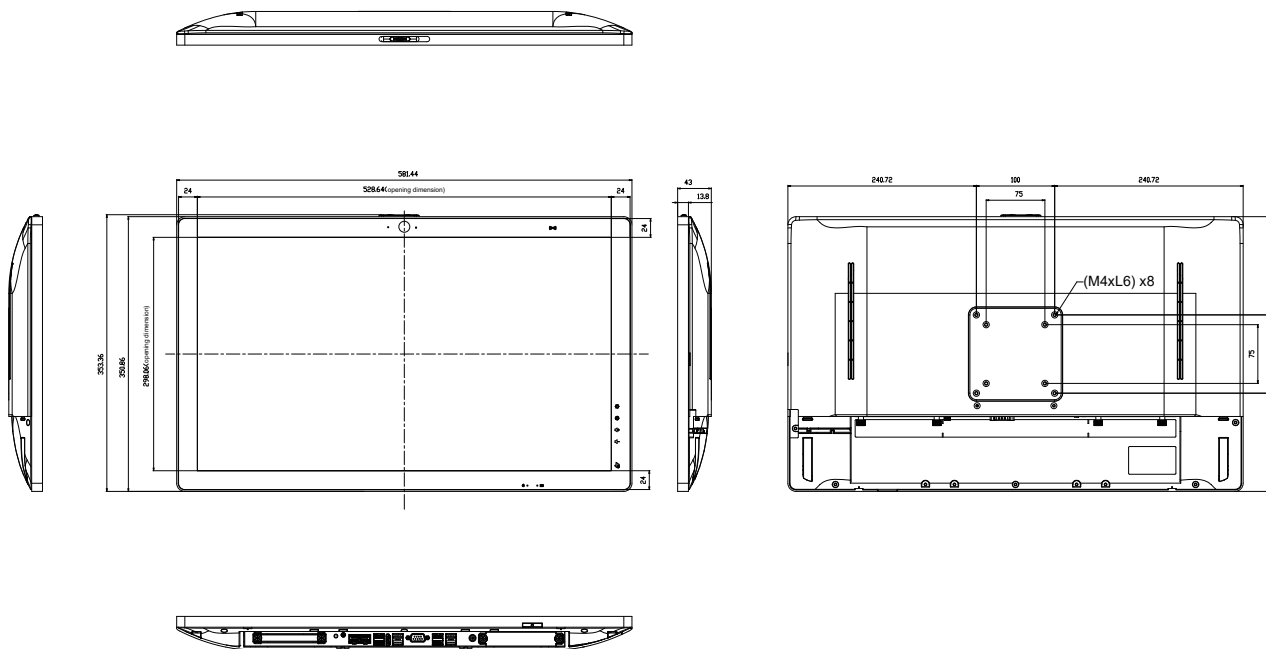

### AG Neovo

Company Address: 5F-1, No. 3-1, Park Street, Nangang District, Taipei, 11503, Taiwan.

Copyright © 2026 AG Neovo. All rights reserved.

TX2410\_UM\_V010