

Quick Start Guide

TXA2401 Medical Panel PC

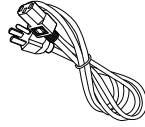

①

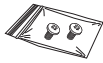
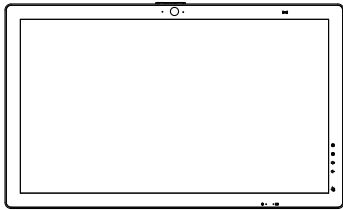
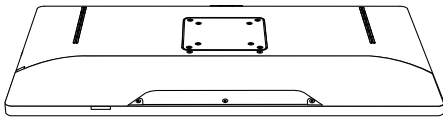

②

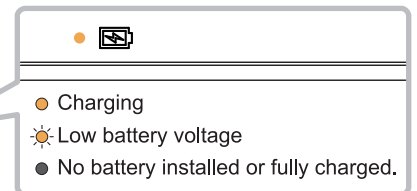
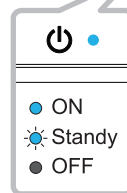
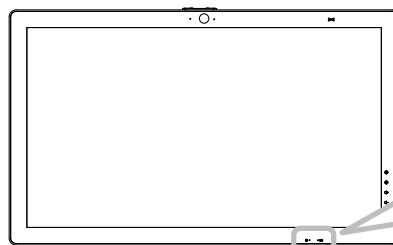
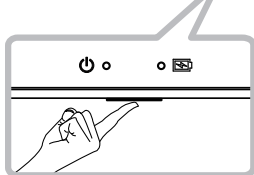
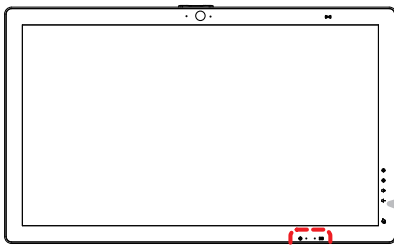
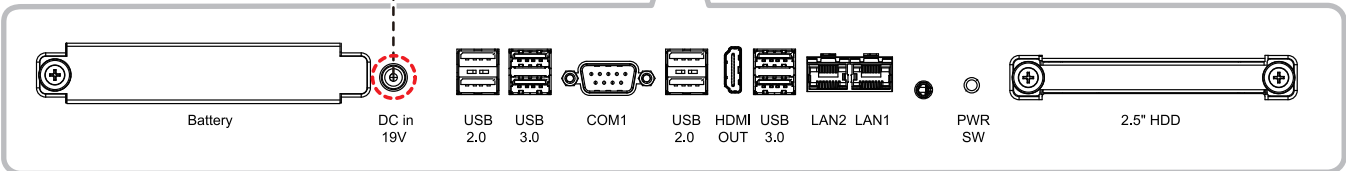
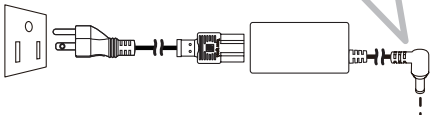
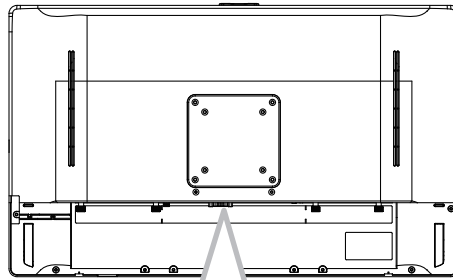
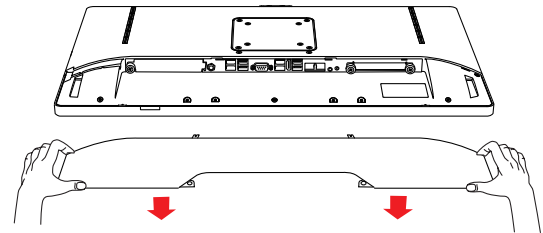

Do not dispose of your product or battery with your household waste. For most up-to-date recycling information, please go to www.agneovo.com/support/recycling

Werfen Sie das Gerät oder die Batterie nicht in den Hausmüll. Die aktuellsten Informationen zum Recycling finden Sie unter www.agneovo.com/support/recycling



Quick Start Guide

TXA2401 Medical Panel PC

WINDOWS 11 ACTIVATION KEY STEPS

1. Scrape off the activation key sticker located on the back of the computer case.

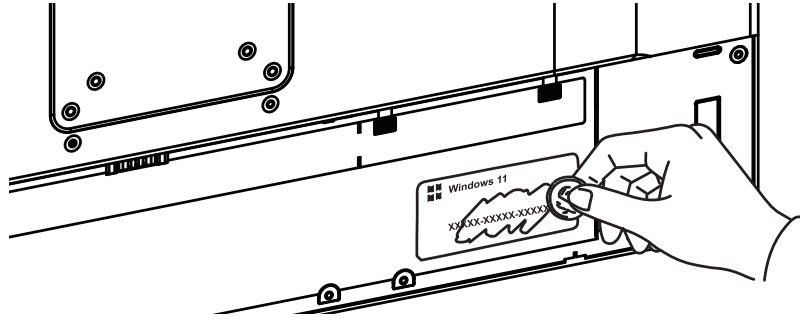

2. Note down or memorize the 25-character product key.

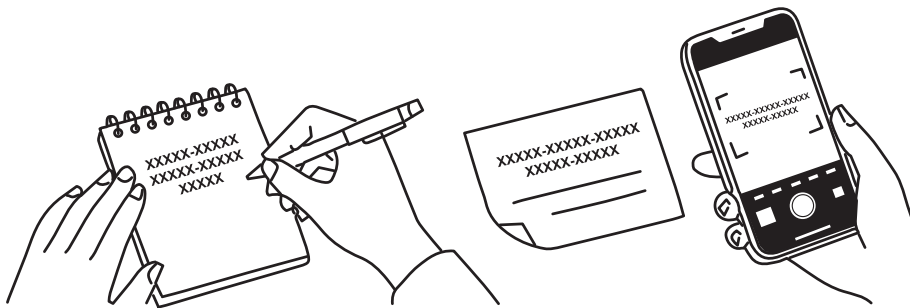

3. Go to Settings > System > About and select "Product key and activation".

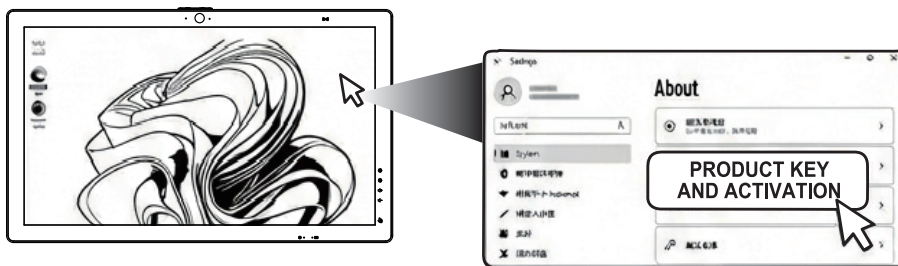

4. Enter the 25-character key to complete the activation process.

