



THE DISPLAY CHOICE
OF PROFESSIONALS™

QX2702 LED-Backlit Monitor

User Manual

www.agneovo.com

TABLE OF CONTENTS

Safety Information

WEEE	4
------------	---

Precautions

Notice	5
Cautions When Setting Up	5
Cautions When Using.....	6
Cleaning and Maintenance.....	7
Notice for the LCD Display	7

CHAPTER 1: PRODUCT DESCRIPTION..... 8

1.1 Unpacking	8
1.2 Package Contents	8
1.3 Preparing for the Installation	9
1.4 Wall Mounting Installation.....	9
1.4.1 VESA Grid	10
1.4.2 Ventilation Requirements for Enclosure Locating	10
1.5 LCD Display Overview	11
1.5.1 Control Panel.....	11
1.5.2 Input/Output Terminals	12
1.6 Remote Control	13
1.6.1 General Functions	13
1.6.2 Inserting the Batteries in the Remote Control	14
1.6.3 Handling the Remote Control	14
1.6.4 Operating Range of the Remote Control.....	15

CHAPTER 2: MAKING CONNECTIONS..... 16

2.1 Control knob Connection.....	17
2.2 External Keypad Connection.....	18

CHAPTER 3: ON SCREEN DISPLAY MENU..... 19

3.1 Using the OSD Menu	19
3.2 OSD Menu Tree	21

CHAPTER 4: ADJUSTING THE LCD DISPLAY 24

4.1 Picture Settings	24
4.2 Audio Settings	26
4.3 Input & Display Settings	27
4.4 Advanced Control Settings	29
4.5 Schedule Settings	32
4.6 Network Settings	33
4.7 System Settings	34
4.8 Information	37

CHAPTER 5: APPENDIX..... 38

5.1 Warning Messages.....	38
5.2 Supported Resolutions	39
5.3 Troubleshooting.....	40

TABLE OF CONTENTS

CHAPTER 6: SPECIFICATIONS	41
6.1 Display Specifications	41
6.2 Display Dimensions	42

SAFETY INFORMATION

WEEE

Disposal of Waste Equipment by Users in Private Household in the European Union.

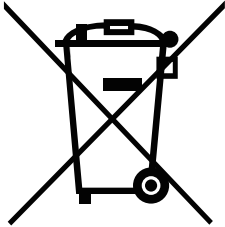

This symbol on the product or on its packaging indicates that this product must not be disposed of with your other household waste. Instead, it is your responsibility to dispose of your waste equipment by handing it over to a designated collection point for the recycling of waste electrical and electronic equipment. The separate collection and recycling of your waste equipment at the time of disposal will help to conserve natural resources and ensure that it is recycled in a manner that protects human health and the environment. For more information about where you can drop off your waste equipment for recycling, please contact your local city office, your household waste disposal service or the shop where you purchased the product

For Private Households in the European Union. To help conserve natural resources and ensure the product is recycled in a manner that protects human health and the environment, we would like to bring your attention to the following:

- The crossed-out dustbin on the device or outer packaging indicates the product is compliant with European WEEE (Waste Electrical and Electronic Equipment) Directive
- Always dispose of the old devices separately from household waste
- Batteries should be removed beforehand and disposed separately to the right collection system
- You are responsible with regard to the deletion of personal data on old devices before disposal
- Private households can hand in their old devices free of charge
- For more information about where you can drop off your waste equipment for recycling, please contact your local city office, your household waste disposal service or the shop where you purchased the product

PRECAUTIONS

PRECAUTIONS



Symbols used in this manual



This icon indicates the existence of a potential hazard that could result in personal injury or damage to the product.



This icon indicates important operating and servicing information.

Notice

- Read this User Manual carefully before using the LCD display and keep it for future reference.
- The product specifications and other information provided in this User Manual are for reference only. All information is subject to change without notice. Updated content can be downloaded from our web site at www.agneovo.com.
- To protect your rights as a consumer, do not remove any stickers from the LCD display. Doing so may affect the determination of the warranty period.

Cautions When Setting Up



Do not place the LCD display near heat sources, such as a heater, exhaust vent, or in direct sunlight.



Do not cover or block the ventilation holes in the housing.



Place the LCD display on a stable area. Do not place the LCD display where it may be subject to vibration or shock.



Place the LCD display in a well-ventilated area.



Do not place the LCD display outdoors.



Do not place the LCD display in a dusty or humid environment.



Do not spill liquid or insert sharp objects into the LCD display through the ventilation holes. Doing so may cause accidental fire, electric shock or damage the LCD display.

PRECAUTIONS

Cautions When Using



Use only the power cord supplied with the LCD display.



The power outlet should be installed near the LCD display and be easily accessible.



If an extension cord is used with the LCD display, ensure that the total current consumption plugged into the power outlet does not exceed the ampere rating.



Do not allow anything to rest on the power cord. Do not place the LCD display where the power cord may be stepped on.



If the LCD display will not be used for an indefinite period of time, unplug the power cord from the power outlet.



To disconnect the power cord, grasp and pull by the plug head. Do not tug on the cord; doing so may cause fire or electric shock.



Do not unplug or touch the power cord with wet hands.

Cleaning and Maintenance



The LCD display comes with NeoV™ Optical Glass. Use a soft cloth lightly moistened with a mild detergent solution to clean the glass surface and the housing.



Do not rub or tap the surface of the glass with sharp or abrasive items such as a pen or screwdriver. This may result in scratching the surface of the glass.



Do not attempt to service the LCD display yourself, refer to qualified service personnel. Opening or removing the covers may expose you to dangerous voltage or other risks.



Warning:



Unplug the power cord from the power outlet and refer to qualified service

personnel under the following conditions:

- ◆ When the power cord is damaged.
- ◆ If the LCD display has been dropped or the housing has been damaged.
- ◆ If the LCD display emits smoke or a distinct odor.



Warning:



Ceiling mount or mount on any other horizontal surface overhead are not advisable.

Installation in contravention of the instructions may result in undesirable consequences, particularly hurting people and damaging property. Users who have already mounted the display on the ceiling or any other horizontal surface overhead are strongly advised to contact AG Neovo for consultations and solutions to help ensure a most pleasurable and fulfilling display experience.

PRECAUTIONS

Notice for the LCD Display

In order to maintain the stable luminous performance, it is recommended to use low brightness setting.

Due to the lifespan of the lamp, it is normal that the brightness quality of the LCD display may decrease with time.

When static images are displayed for long periods of time, the image may cause an imprint on the LCD display. This is called image retention or burn-in.

To prevent image retention, do any of the following:

- Set the LCD display to turn off after a few minutes of being idle.
- Use a screen saver that has moving graphics or a blank white image.
- Switch desktop backgrounds regularly.
- Adjust the LCD display to low brightness settings.
- Turn off the LCD display when the system is not in use.

Things to do when the LCD display shows image retention:

- Turn off the LCD display for extended periods of time. It can be several hours or several days.
 - Use a screen saver and run it for extended periods of time.
 - Use a black and white image and run it for extended periods of time.
-

There are millions of micro transistors inside the LCD display. It is normal for a few transistors to be damaged and to produce spots. This is acceptable and is not considered a failure.

CHAPTER 1: PRODUCT DESCRIPTION

1.1 Unpacking

- This product is packed in a packaging box which contains standard accessories.
- Any other optional accessories will be packed separately.
- Considering the size and weight of the display, it is recommended that this product is carried out by two persons.
- After opening the packaging box, ensure that the included items are in good condition and complete.

1.2 Package Contents

When unpacking, check if the following items are included in the package. If any of them is missing or damaged, contact your dealer.

LCD Display

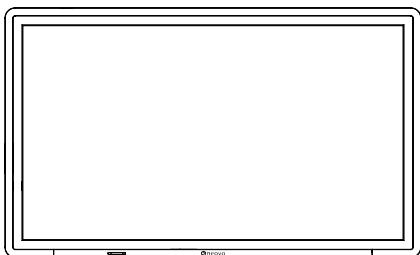

Remote control



Quick Start Guide



HDMI cable

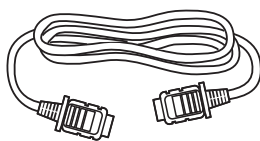

Power adapter

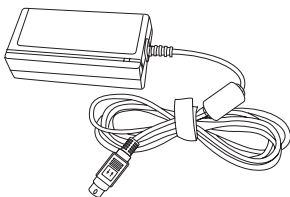

Power Cord

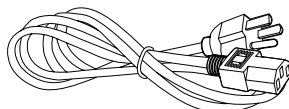

Note:



Attention!!
Batteries not included.

- ◆ No batteries for remote control are included.
- ◆ Remote control requires 2x AAA battery.
- ◆ For all other regions, apply a power cord that conforms to the AC voltage of the power socket and has been approved by and complies with the safety regulations of the particular country (Type H05W-F, 2G or 3G, 0.75 or 1 mm² should be used).
- ◆ QX2702 must use only the supplied power adapter: FUJIA (Shenzhen Fuja Machinery Co., Ltd)
Model no.: FJ-GN213524005500
Rating: 24V/5.5A
- ◆ The pictures are for reference only. Actual items may vary upon shipment.

PRODUCT DESCRIPTION

1.3 Preparing for the Installation

- Due to the high power consumption, always use the plug exclusively designed for this product. If an extended line is required, please consult your service agent.
- The product should be installed on a flat surface to avoid tipping. The distance between the back of the product and the wall should be maintained for proper ventilation. Avoid installing the product in the kitchen, bathroom or any other places with high humidity so as not to shorten the service life of the electronic components.
- The product can normally operate only under 3000m in altitude. In installations at altitudes above 3000m, some abnormalities may be experienced.

1.4 Wall Mounting Installation

To mount this display to a wall, you will have to obtain a standard wall-mounting kit (commercially available). We recommend using a mounting interface that complies with TUV-GS and/or UL1678 standard in North America.

To wall-mount the LCD display, screw the mounting bracket to the VESA holes at the rear of the LCD display.

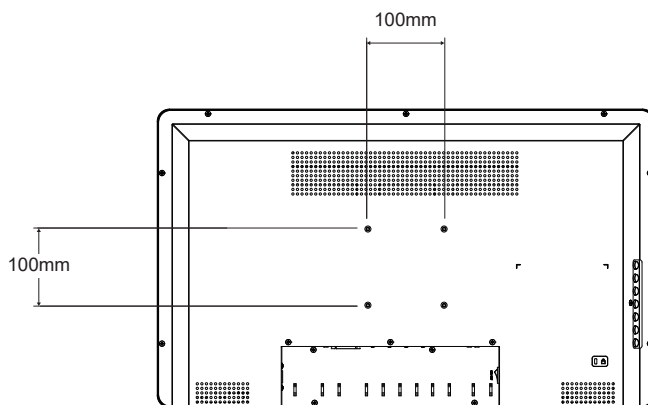

Warning:

- ◆ Do not press too hard on the LCD panel or edge of the frame, as this may cause the device to malfunction.

Note:

- ◆ Avoid the wall-mounting kit to block the ventilation holes on the back of the display.
- ◆ Secure the LCD display on a solid wall strong enough to bear its weight.
- ◆ Lay a protective sheet on a table, which was wrapped around the display when it was packaged, beneath the screen surface so as not to scratch the screen face.
- ◆ Ensure you have all accessories for mounting this display (wall mount, ceiling mount, etc).
- ◆ Follow the instructions that come with the base mounting kit. Failure to follow correct mounting procedures could result in damage to the equipment or injury to the user or installer. Product warranty does not cover damage caused by improper installation.

PRODUCT DESCRIPTION

1.4.1 VESA Grid

Model Name	VESA Grid
QX2702	100(W) x 100(H) mm

Caution:

To prevent the display from falling:

- ◆ For wall or ceiling installation, we recommend installing the display with metal brackets which are commercially available. For detailed installation instructions, see the guide received with the respective bracket.
- ◆ To lessen the probability of injury and damage resulting from fall of the display in case of earthquake or other natural disaster, be sure to consult the bracket manufacturer for installation location.

1.4.2 Ventilation Requirements for Enclosure Locating

To allow heat to disperse, leave space between surrounding objects as shown in the diagram below.

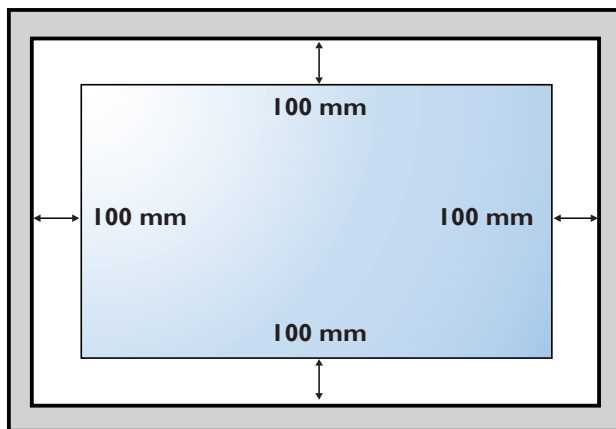

Note:

- ◆ For the wall-mounting kit, use M4 screws for QX2702 (with a length at least 8 mm longer than the thickness of the wall mount bracket) and then securely tighten the screws.

PRODUCT DESCRIPTION

1.5 LCD Display Overview

1.5.1 Control Panel

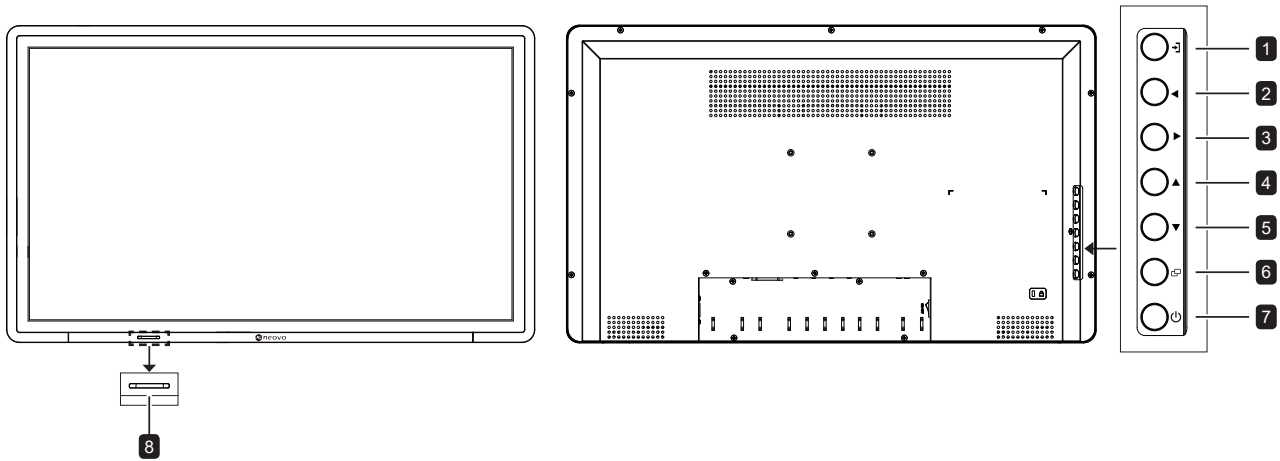

1 [→] SOURCE

Choose the input source.
Closes the OSD menu or exits a submenu while OSD menu is on.

2 [←] LEFT

Press the left key to select the menu item.
Decreases the adjustment while a setting be selected.

3 [→] RIGHT

Press the right key to select the menu item and submenu.
Increases the adjustment while a setting be selected.

4 [▲] UP

During OSD menu selection, press to move up to select the menu item.

5 [▼] DOWN

During OSD menu selection, press to move down to select the menu item.

6 [□] MENU

Activates the OSD menu when OSD menu is off.
Selects items or accepts the settings in the OSD menu.

7 [⏻] POWER

Turns the display on or off.

8 Remote control sensor, power status indicator and EcoSmart sensor

- Receive command signals from the remote control.
- Indicate the operating status of the display:
 - Lights blue when the display is turned on
 - Lights amber when the display is in standby mode.
 - Lights off when the main power of the display is turned off.
- Users can enable the Eco Smart feature to automatically adjust the LCD screen brightness according to the ambient light. This feature comforts the eyes and helps optimise energy efficiency.

Note: Please make sure the EcoSmart sensor is not covered when enabling this function.

PRODUCT DESCRIPTION

1.5.2 Input/Output Terminals

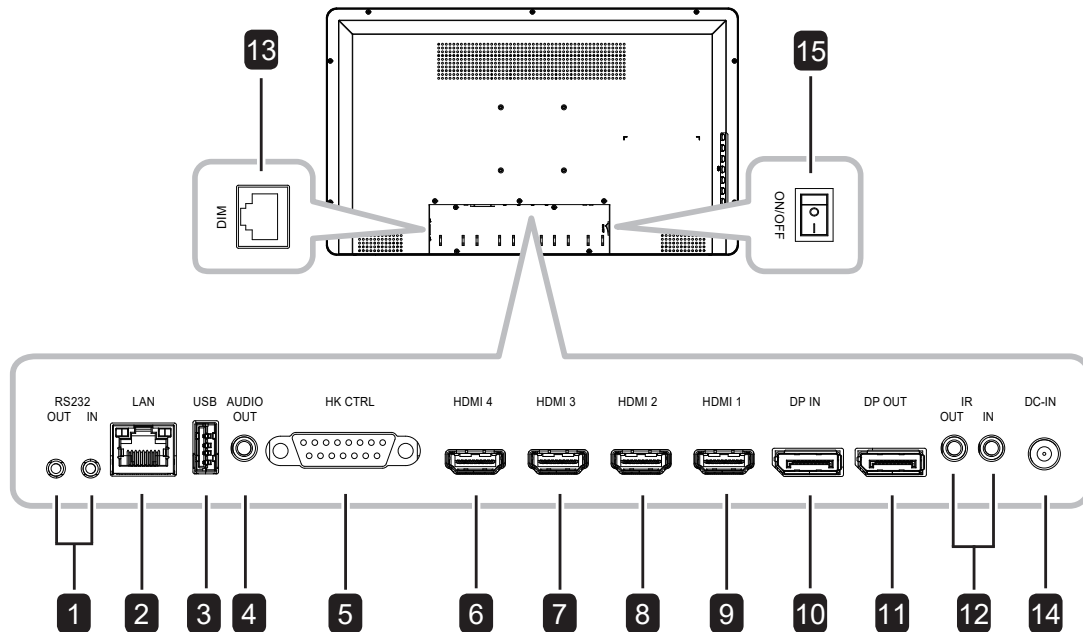

- 1 RS232 (OUT / IN)**
Connect RS232 input from external equipment.
- 2 LAN**
For LAN connection with an Ethernet cable.
- 3 USB**
USB Port for USB firmware upgrade.
- 4 AUDIO OUT**
Connect audio signals output (3.5 mm Stereo Audio Jack).
- 5 HK CTRL**
Connect HotKey Control input.
- 6 HDMI 4**
Connect HDMI(2.0) signals input.
- 7 HDMI 3**
Connect HDMI(2.0) signals input.
- 8 HDMI 2**
Connect HDMI(1.4/2.0) signals input.
- 9 HDMI 1**
Connect HDMI(1.4/2.0) signals input.
- 10 DP(DisplayPort) IN**
Connect DP(1.1/1.2) signals input.
- 11 DP(DisplayPort) OUT**
Connect DisplayPort signals output.
- 12 IR (OUT / IN)**
IR signal In/Output for the loop-through function.
This display's remote control sensor will stop working if the jack [IR IN] is connected.
- 13 DIM**
Connect Brightness Dimming Control input.
- 14 DC IN**
Connect with the supplied power adaptor.
- 15 ON / OFF**
Switch the main power on/off.

PRODUCT DESCRIPTION

1.6 Remote Control

1.6.1 General Functions

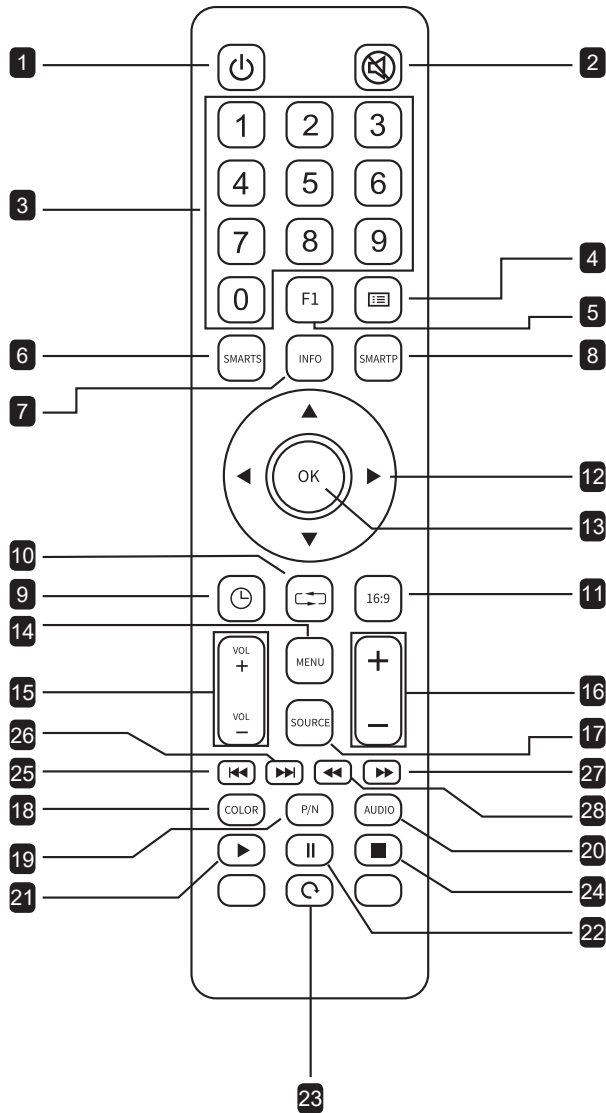

1 [POWER]

Turns the display on/off.

2 [MUTE]

Turns the mute function on/off.

3 [Number]

Directly select the number keys for IP settings.

4 [List]

No function.

5 [F1] Freeze

Freezes or unfreezes the screen image.

6 [SMARTS] PIP/PBP

Selects the **OFF/PIP/PBP/PBP 2/PBP 3/PBP 4**

7 [INFO]

Displays signal type and resolution

8 [SMARTP] Picture Mode

Selects the preferred picture mode. The available modes include: **Standard/Signage/Video/Surveillance/Reading**

9 [Timer]

No function.

10 [Back]

Exits from the previous function.

11 [16:9] Aspect Ratio

Changes the aspect ratio.

12 [Navigation Buttons]

Navigates through menus and chooses items.

13 [OK]

Confirms an entry or selection.

14 [MENU]

Accesses the OSD menu or Exit menu.

15 [Volume Button]

Adjusts volume. Press ^{VOL} + to increase volume or press ^{VOL} - to decrease volume.

16 [Backlight]

Adjusts backlight function.

17 [SOURCE]

Selects the input source.

18 [COLOR] Colour Temperature

Selects the colour temperature.

19 ~ 22

No function.

23 [Back]

Exits from the previous function.

24 ~ 28

No function

PRODUCT DESCRIPTION

1.6.2 Inserting the Batteries in the Remote Control

The remote control is powered by two 1.5V AAA batteries.

To install or replace batteries:

- 1 Press and then slide the cover to open it.
- 2 Align the batteries according to the (+) and (-) indications inside the battery compartment.
- 3 Replace the cover.

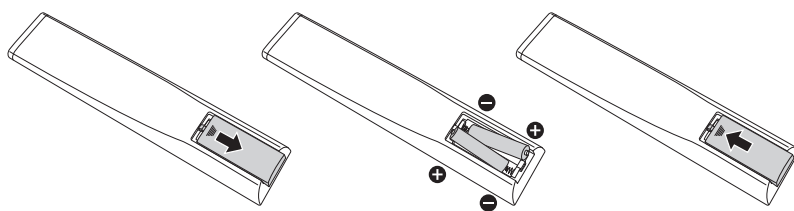

1.6.3 Handling the Remote Control

- Do not subject to strong shock.
- Do not allow water or other liquid to splash the remote control. If the remote control gets wet, wipe it dry immediately.
- Avoid exposure to heat and steam.
- Other than to install the batteries, do not open the remote control.

Caution:

The incorrect use of batteries can result in leaks or bursting. Be sure to follow these instructions:

- ◆ Place “AAA” batteries matching the (+) and (-) signs on each battery to the (+) and (-) signs of the battery compartment.
- ◆ Do not mix battery types.
- ◆ Do not combine new batteries with used ones. It causes shorter life or leakage of batteries.
- ◆ Remove the dead batteries immediately to prevent them from liquid leaking in the battery compartment. Don't touch exposed battery acid, as it can damage your skin.

Note:

- ◆ If you do not intend to use the remote control for a long period, remove the batteries.
- ◆ The remote control may not function properly when the remote control sensor on this display is under direct sunlight or strong illumination, or when there is an obstacle in the path of signal transmission.

PRODUCT DESCRIPTION

1.6.4 Operating Range of the Remote Control

Point the top of the remote control toward the display's remote control sensor (on the right side) when pressing a button.

When using the remote control, the distance from the remote control to the sensor on the display should be less than 8m/26ft, and the horizontal and vertical angles should be less than 30°.

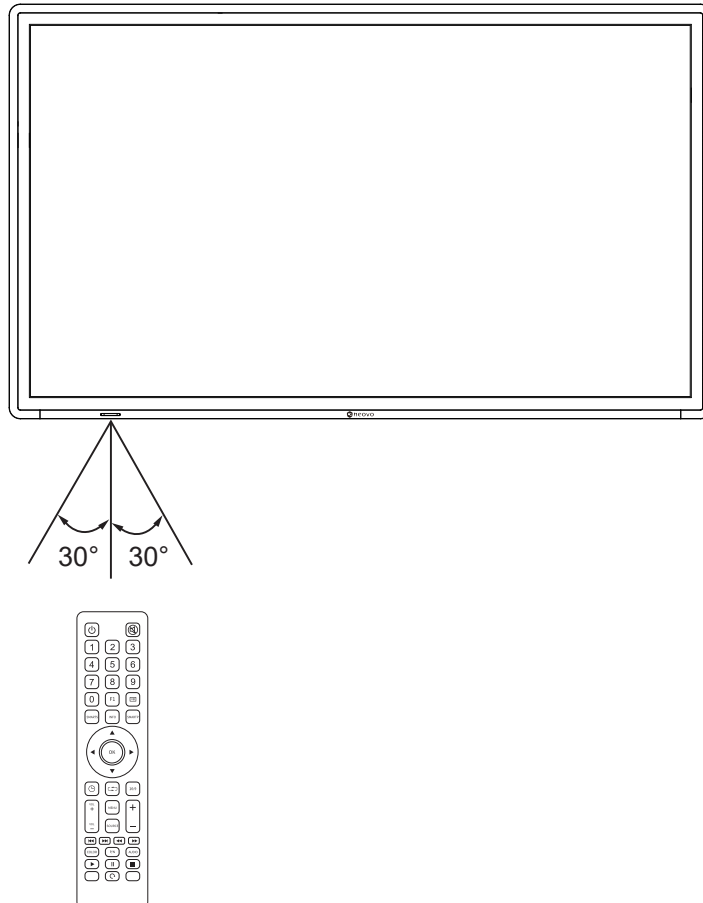

CHAPTER 2: MAKING CONNECTIONS

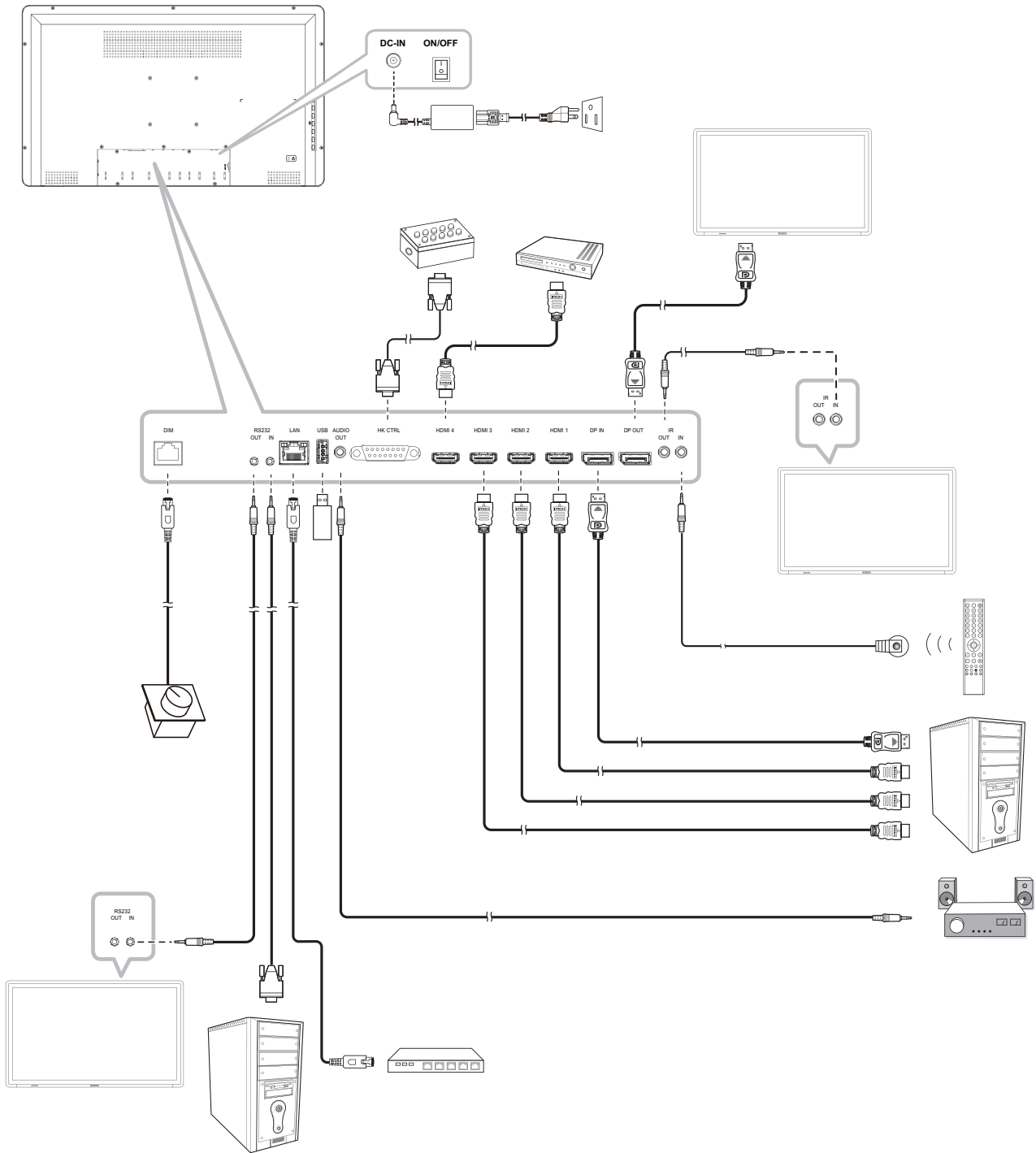

MAKING CONNECTIONS

2.1 Control knob Connection

Connection Purpose

The Control knob allows users to adjust the display's brightness using an external rotary encoder. This is especially useful in control rooms or dark-room surveillance environments where quick, tactile brightness control is required.

How to Connect

- **Connect the RJ45 cable according to the following pin definition:**

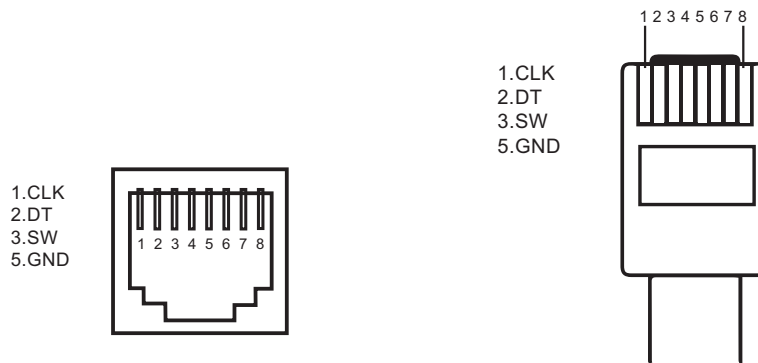

Pin	Usage
1	ENCODER_CLK
2	ENCODER_DT
3	ENCODER_SW
5	GND

How to Use

- **Rotate the encoder knob** to increase or decrease the brightness.
- **Press the encoder switch (SW)** if configured for additional functions such as reset or quick preset.

MAKING CONNECTIONS

2.2 External Keypad Connection

Connection Purpose

The External Keypad allows users to control the display through an external keypad. This is ideal for operators who require fast, direct access to frequently used commands.

How to Connect

1. Locate the **D-sub 15-pin connector** on the display.
2. Connect each keypad button according to the pin define table:

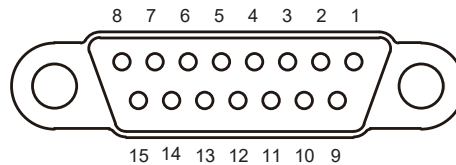

Function	Description	Pin
Key1	Blackout	1
Key2	Restore	2
Key3	Backlight 0	3
Key4	Backlight +	4
Key5	Backlight -	5
Key6	Custom Key	6
GND	GROUNDING	7
Key7	Custom Key	8
Key8	Custom Key	9
Key9	Custom Key	10
Key10	Custom Key	11
GND	GROUNDING	12
+5V	DC Output +5V (2A)	13
+12V	DC Output +12V(1A)	14
GND	GROUNDING	15











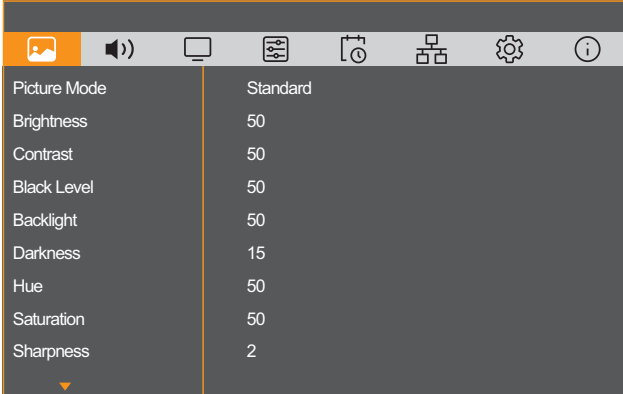



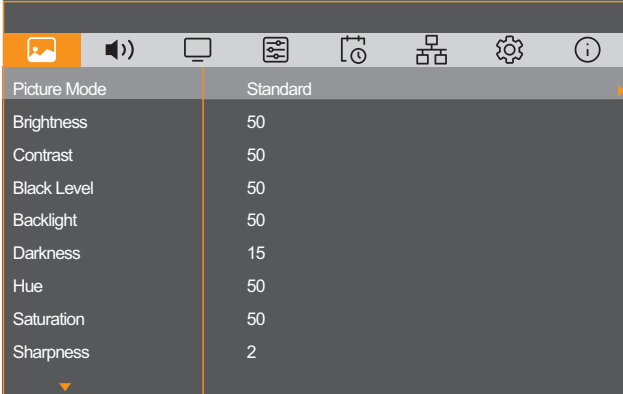

How to Use

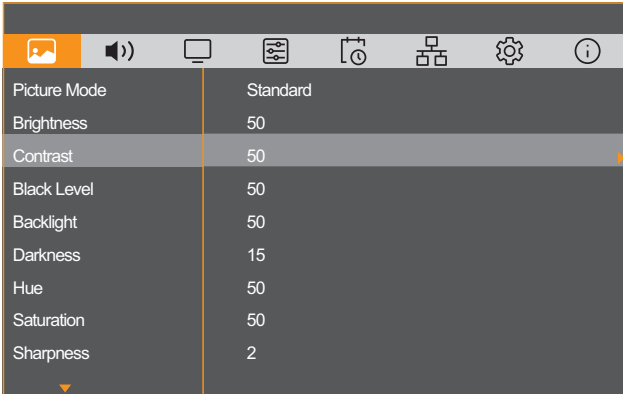
- Please refer to Page 30.







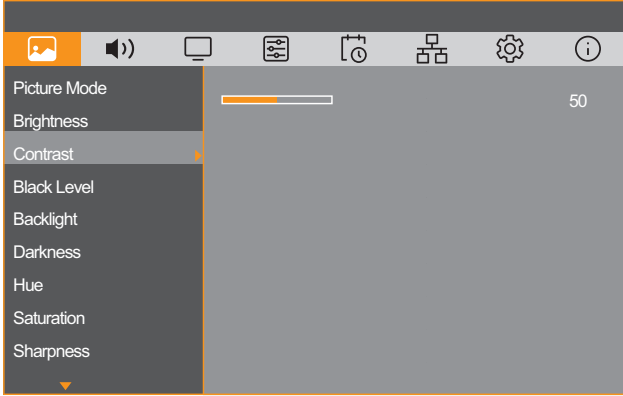

Note : Use the +5V or +12V output pins if powering the keypad module directly from the display.

CHAPTER 3: ON SCREEN DISPLAY MENU

3.1 Using the OSD Menu

#	Menu Navigation	Operation	
		Control Panel	Remote Control
1	<p>Display the main menu screen.</p> 	<p>1 Press the  button.</p> <p>2 Press the  or  button to select the menu item.</p>	<p>1 Press the MENU button.</p> <p>2 Press the  or  button to select the menu item.</p>
2	<p>Enter the menu screen.</p> 	<p>Press the  button to enter the menu screen.</p>	<p>Press the OK button to enter the menu screen.</p>
3	<p>Enter the submenu.</p>  <p>The highlighted item (light gray) indicates the active submenu.</p>	<p>Press the  or  button to select the menu item.</p> <p>If the menu item has the submenu, press the  or  button to enter its submenu.</p>	<p>Press the  or  button to select the menu item.</p> <p>If the menu item has the submenu, press the OK or  button to enter its submenu.</p>

ON SCREEN DISPLAY MENU

#	Menu Navigation	Operation	
		Control Panel	Remote Control
4	Select the setting or adjust the value. 	Press the ▲/▼ or ◀/▶ button to select the setting or change the value. Then press the  button to confirm.	Press the ▲/▼ or ◀/▶ button to select the setting or change the value. Then press the OK button to confirm.
5	Exit the submenu.	Press the  button to return to the previous menu.	Press the  button to return to the previous menu or  button.
6	Close the OSD window.	Press the  button for several times if necessary to exit.	Press the  button for several times if necessary to exit or  button.

Note:

When settings are modified, all changes are saved when the user does the following:

- Proceeds to the another menu.
- Exits the OSD menu.
- Waits for the OSD menu to disappear.

If a menu item is unavailable, it will be disabled and grayed out.

ON SCREEN DISPLAY MENU

3.2 OSD Menu Tree

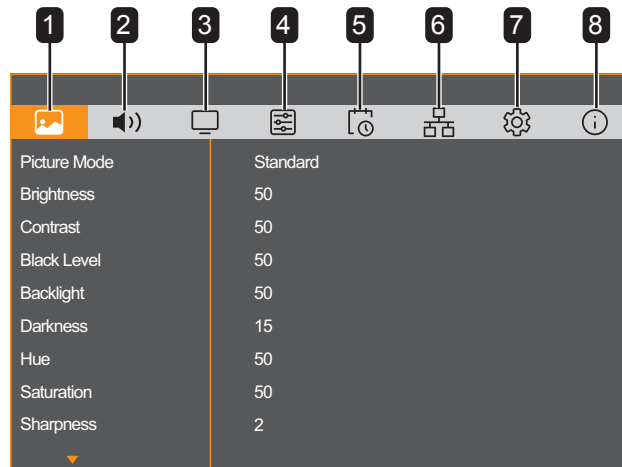

Main Menu	Submenu	Remarks
1. Picture	<ul style="list-style-type: none"> • Picture Mode • Brightness • Contrast • Black Level • Backlight • Darkness • Hue • Saturation • Sharpness • Colour Temp. • Gamma • Screen Rotation • Win 1 Aspect Ratio • Win 2 Aspect Ratio • Win 3 Aspect Ratio • Win 4 Aspect Ratio 	See page 24.
2. Audio	<ul style="list-style-type: none"> • Volume • Mute • Audio Source Detection 	See page 26.
3. Input & Display	<ul style="list-style-type: none"> • PIP Mode • PIP Size • PIP Position • PIP Swap • Win 1 Source • Win 2 Source • Win 3 Source • Win 4 Source • DP Output • Source Switching • Failover 1 • Failover 2 • Failover 3 • Failover 4 	See page 27.

ON SCREEN DISPLAY MENU

Main Menu	Submenu	Remarks
4. Advanced Control	<ul style="list-style-type: none"> • Anti-Burn-In • Anti-Burn-In Interval (Hrs) • Monitor ID • RS-232 Routing • Sync Dimming • Sync Keys • Custom Keys • Date • Time • Status Feedback 	See page 29.
5. Schedule	<ul style="list-style-type: none"> • Schedule 1 • Schedule 2 • Schedule 3 • Schedule 4 • Schedule 5 • Schedule 6 • Schedule 7 	See page 32.
6. Network	<ul style="list-style-type: none"> • LAN • TCP Keep-Alive • IP Assignment • IP Address • Subnet Mask • Gateway • Primary DNS • Secondary DNS 	See page 33.
7. System	<ul style="list-style-type: none"> • OSD Language • OSD H. POS. • OSD V. POS. • OSD Size • OSD Timer • OSD Transparency • OSD Rotation • DP Version • HDMI Version • Colour Range • LED Indicator • ECO Smart Sensor • Logo • Key Lock • IR Lock • Message Display • USB FW Update • DDC/CI • Switch On State • Standby • Wake On LAN • User Profiles • Factory Reset 	See page 34.

ON SCREEN DISPLAY MENU

Main Menu	Submenu	Remarks
8. Information	<ul style="list-style-type: none">• Model Name• Serial No.• Temperature• Input Source• FW Version• MCU Version• MAC Address• Anti-Burn-in Count• Operation Hours	See page 37.

CHAPTER 4: ADJUSTING THE LCD DISPLAY

4.1 Picture Settings



Item	Function	Range
Picture Mode	Select the predefined picture setting. <ul style="list-style-type: none"> Standard: Designed primarily for text-based computer use, such as in offices and conference rooms. Suitable for most environments. Signage: Suitable for use in public information displays, retail store windows, and digital signage applications. Video: Suitable for video playback and video conferencing scenarios. Surveillance: Designed for a variety of monitoring environments, including security and industrial surveillance. Reading: Suitable for long-duration viewing applications, such as document processing and use in dimly lit environments. 	Standard Signage Video Surveillance Reading
Brightness	Adjust the brightness of the screen image.	0 to 100
Contrast	Adjust the difference between the black level and the white level.	0 to 100
Black Level	Adjust the black level of the screen image. Low brightness setting makes black colour darker.	0 to 100
Backlight	Adjust the luminance of the screen image.	0 to 100
Darkness	Adjust the screen's darkest threshold when the backlight is set to 0. If the screen becomes too dark to see the OSD, increase the backlight using the remote control or hotkey control device.	1 to 30
Hue	Adjust colour balance of red and green.	0 to 100
Saturation	Adjust the color saturation of the picture.	0 to 100
Sharpness	Adjust the clarity and focus of the screen image.	0 1 2 3 4

ADJUSTING THE LCD DISPLAY

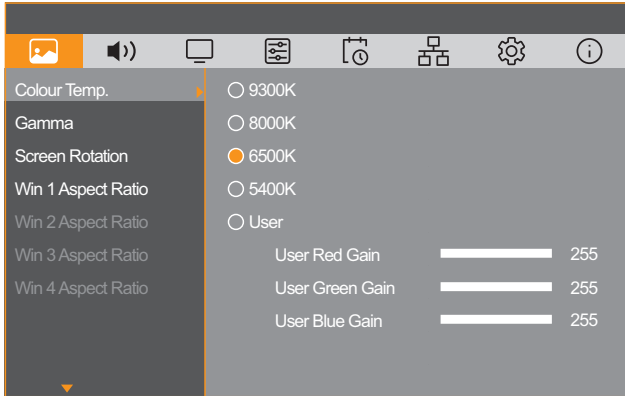
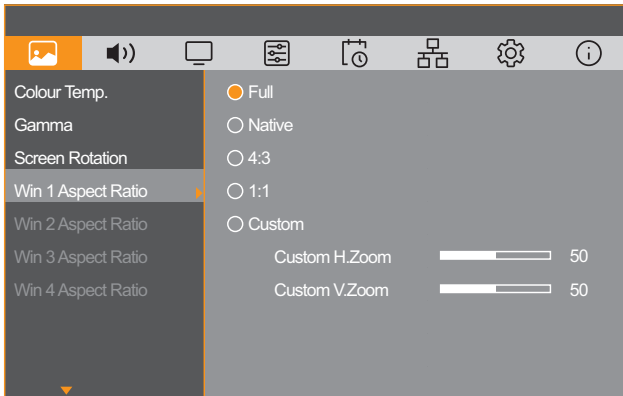
Item	Function	Range
Colour Temp.		
	Colour Temp.: Select a color temperature for the image. A lower color temperature will have a reddish tint, whilst a higher color temperature gives off a more bluish tint.	9300K 8000K 6500K 5400K User
	User: Adjust the right-tone of the red/green/blue component when the Colour Temp. is set to User .	User Red Gain User Green Gain User Blue Gain
Gamma	Adjust the non-linear setting for picture luminance and contrast.	1.8 2.0 2.2 2.4 2.6
Screen Rotation	Set the LCD display orientation according to its mounting position. Note: This menu option is not supported in PIP mode.	0° 180°
Win 1 Aspect Ratio Win 2 Aspect Ratio Win 3 Aspect Ratio Win 4 Aspect Ratio	Adjust the aspect ratio of each window when PIP mode is enabled. 	
	Note: This option is available only in PIP mode. When PIP is off and you need to adjust the aspect ratio, select Win1 Aspect Ratio .	
	Aspect Ratio: Adjust the aspect ratio of the screen image.	Full Native 4:3 1:1 Custom
	Custom: Expand the image size when the Aspect Ratio is set to Custom .	Custom H.Zoom Custom V.Zoom

ADJUSTING THE LCD DISPLAY

4.2 Audio Settings

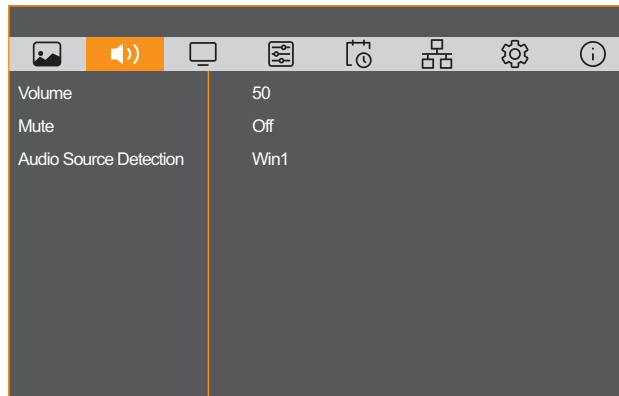

Item	Function	Range
Volume	Adjust the volume level.	0 to 100
Mute	Turn the mute function on/off.	Off On
Audio Source Detection	Set the audio input source. Note: This menu option is available only when PIP mode is enabled.	Win 1 Win 2 Win 3 Win 4

ADJUSTING THE LCD DISPLAY

4.3 Input & Display Settings

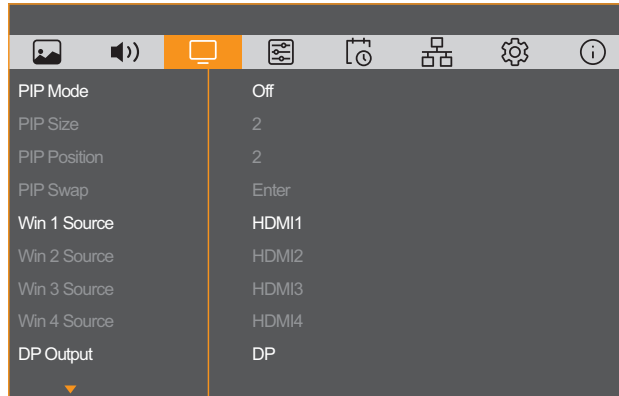

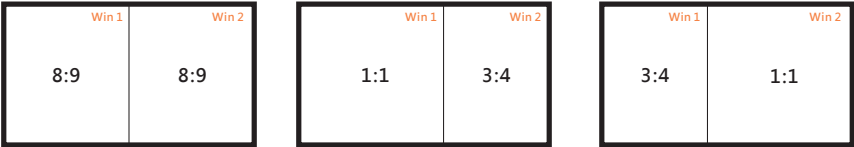
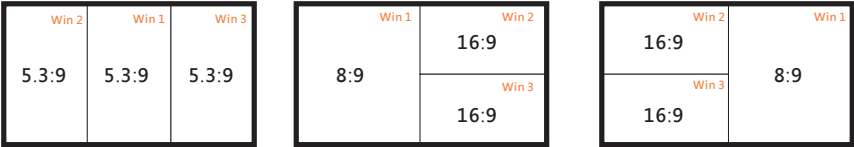
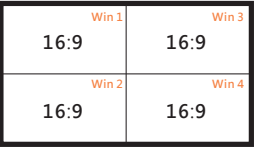
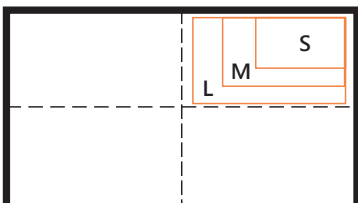
Item	Function	Range
PIP Mode	<p>Select PIP (Picture-in-Picture) mode, PBP (Picture-by-Picture) mode, or turn it off.</p> <p>2P (PBP)</p>  <p>3P (PBP)</p>  <p>4P (PBP)</p> 	<p>Off</p> <p>PIP</p> <p>PBP 2</p> <p>PBP 3</p> <p>PBP 4</p>
PIP Size	<p>Adjust the size of the sub-picture in PIP mode (1: small, 2: medium, 3: large)</p> 	<p>1</p> <p>2</p> <p>3</p>

ADJUSTING THE LCD DISPLAY

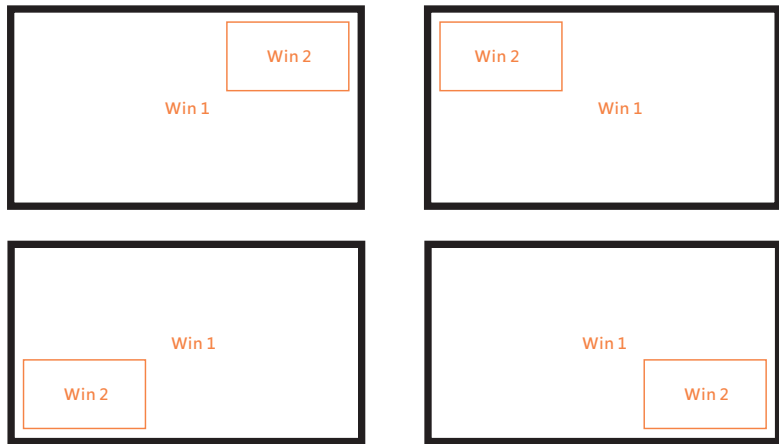
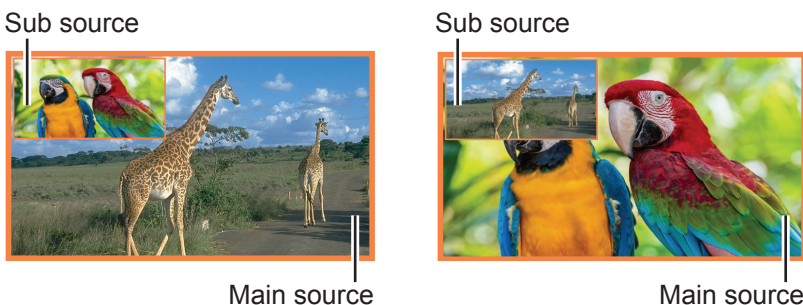
Item	Function	Range
PIP Position	<p>Change the position of the sub picture in the PIP mode.</p> 	1 2 3 4
PIP Swap	<p>Enable this feature to switch between the main and sub picture windows in PIP or PBP 2.</p> 	-
Win 1 Source Win 2 Source Win 3 Source Win 4 Source	<p>Set the input source for the multiple windows.</p> <p>Note: The DP input source cannot be selected when PIP mode is enabled.</p>	HDMI 1 HDMI 2 HDMI 3 HDMI 4
DP Output	<p>Duplicate the currently displayed input source to the external display via DP Out connection.</p> <p>Note: When PIP mode is enabled, each window supports resolutions up to 4K at 30Hz.</p>	Win 1 Win 2 Win 3 Win 4
Source Switching	<p>Select how the display detects input signals: manual, automatic, or automatic with failover when the main source is missing.</p> <p>Manual: Switches sources manually.</p> <p>Auto: Auto: Automatically detects and switches to an active signal, with the priority order of HDMI1 → HDMI2 → HDMI3 → HDMI4 → DP.</p> <p>Failover: When the primary source is lost, it automatically switches to the backup source.</p> <p>Note: This menu option is not supported in PIP mode.</p>	Manual Auto Failover
Failover 1 Failover 2 Failover 3 Failover 4	<p>If the Source Switching setting is set to Failover, you can configure the input source priority list (Failover1~Failover4) in case of multiple sources.</p> <p>Note: This menu option is not supported in PIP mode.</p>	HDMI 1 HDMI 2 HDMI 3 HDMI 4 DP None

ADJUSTING THE LCD DISPLAY

4.4 Advanced Control Settings

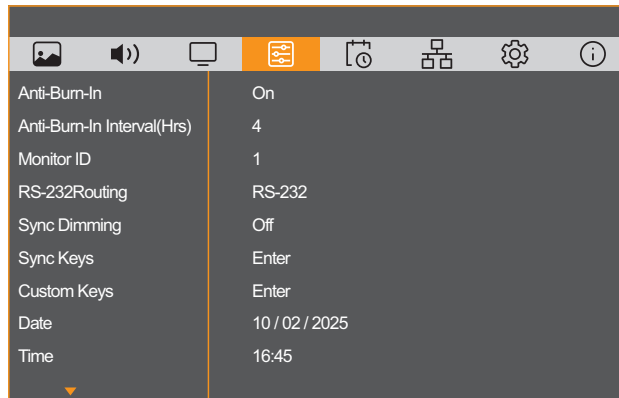

Item	Function	Range
Anti-Burn-In	Enable or disable Anti-Burn-in™ function.	Off On
Anti-Burn-In Interval (Hrs)	Set the interval time (hours) between activating the Anti-Burn-In function.	2 3 4 5 6 8
Monitor ID	Adjust the ID number for controlling the display via the Command Control connection. Each display must have a unique ID number when multiple sets of this display are connected.	1 to 255
RS-232 Routing	Select the control command input source.	RS-232 LAN to RS-232
Sync Dimming	Enable commands to be applied to all connected devices. When off, commands affect only this unit. Automatically disabled when ECO Smart Sensor is on.	Off On

ADJUSTING THE LCD DISPLAY

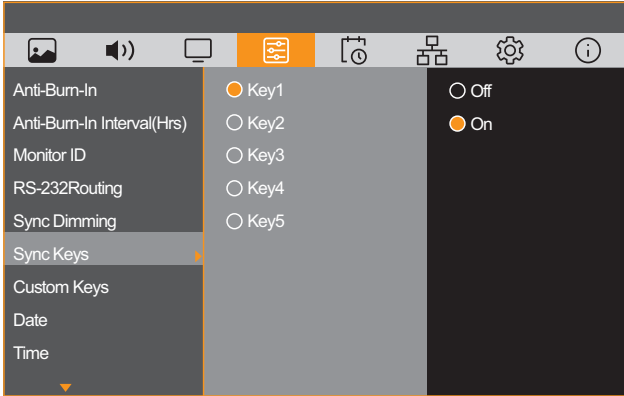
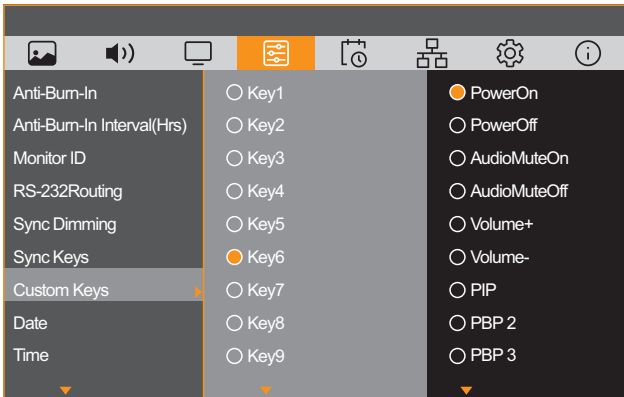
Item	Function	Operation	Range
Sync Keys	<p>Enables or disables each hotkey individually, allowing it to operate on all connected devices or only on this unit.</p>  <p>The default functions are:</p> <ul style="list-style-type: none"> • Key 1: Blackout • Key 2: Restore • Key 3: Backlight 0 • Key 4: Backlight + • Key 5: Backlight - <p>Note: Select Key1–Key5 to specify whether synchronization is enabled. Once selected, ensure that Sync Dimming is set to ON to activate synchronization.</p>	Key 1 Key 2 Key 3 Key 4 Key 5	Off On
Custom Keys	 <p>Assign a function for the designated hotkey (Key 6~10) on the hotkey controller.</p> <p>Available options: Power On (Wake up only available for Standby normal or Standby off, please refer to Page 36), Power Off, Audio Mute On, Audio Mute Off, Volume +, Volume -, PIP Off, PIP, PBP 2, PBP 3, PBP 4, HDMI1, HDMI2, HDMI3, HDMI4, DP, Picture Freeze, Picture Unfreeze.</p> <p>Note: The following functions are not supported in PIP mode:</p> <ul style="list-style-type: none"> • Freeze • Failover • Scheduling 	Key 6 Key 7 Key 8 Key 9 Key 10	Power On Power Off Audio Mute On Audio Mute Off Volume + Volume - PIP Off PIP PBP 2 PBP 3 PBP 4 HDMI 1 HDMI 2 HDMI 3 HDMI 4 DP Picture Freeze Picture Unfreeze
Date	Set the date.		MM/DD/YYYY
Time	Set the time.		HH:MM

ADJUSTING THE LCD DISPLAY

Item	Function	Range
Status Feedback	<p>Signal Loss Alert: Enable or disable to trigger a warning alert when the input signal is lost.</p> <p>25 07 01 00 66 37 01 0D Signal loss</p> <p>Note: When this function is enabled, the command response will be sent via the LAN or RS232 interface once the event is triggered.</p>	<p>Off</p> <p>On</p>
	<p>Overheat Alert: Enable or disable to trigger a temperature warning alert when the internal temperature is high.</p> <p>25 07 01 00 66 37 02 0D Overheat warning</p> <p>Note: WWhen this function is enabled, the command response will be sent via the LAN or RS232 interface once the event is triggered.</p>	<p>Off</p> <p>On</p>

ADJUSTING THE LCD DISPLAY

4.5 Schedule Settings

This function allows you to program up to 7 different scheduled time intervals for this display to activate.

You can set:

- Which input source the display will use for each scheduled activation period.
- The time for the display to turn on and turn off.
- The days in a week for the display to activate.

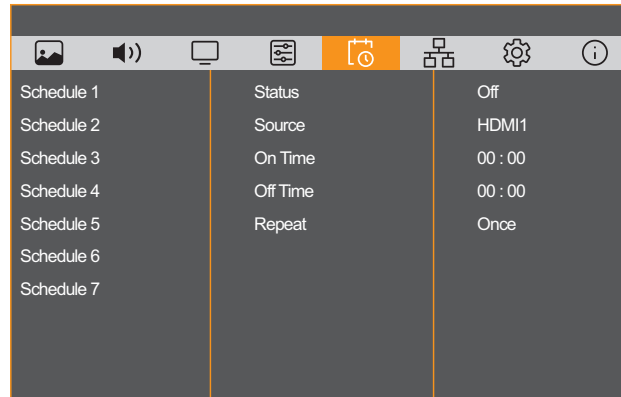

Note:

- We recommend you to set up current date and time in the Advanced Control menu before using this function.
- After changing the Date or Time options in the Advanced Control menu, you need to set this Schedule again.

Item	Function	Range
Status	Enable or disable the schedule.	Off On
Source	Set the input source.	HDMI 1 HDMI 2 HDMI 3 HDMI 4 DP
On Time	Specify the time to turn on the display.	HH:MM
Off Time	Specify the time to turn off the display.	HH:MM
Repeat	Select the days of the week when the schedule is active.	Once Everyday Mon Tue Wed Thu Fri Sat Sun

ADJUSTING THE LCD DISPLAY

4.6 Network Settings

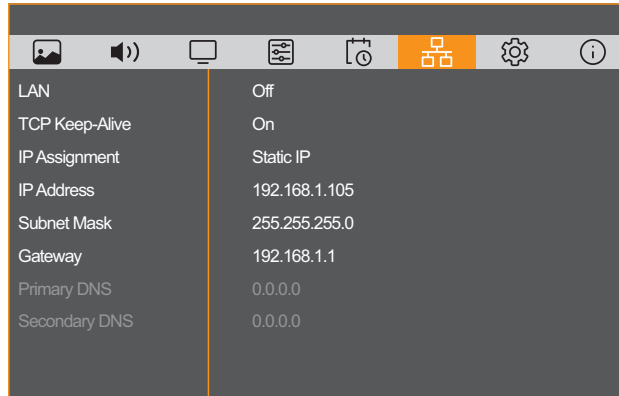

Item	Function	Range
LAN	Enable or disable the wired network connection.	Off On
TCP Keep-Alive	Enable this feature to keep TCP connections active even when there is no data transmission by sending a command to the router every 45 seconds.	Off On
IP Assignment	Select DHCP to allow the system to assign an IP address automatically. Otherwise, select Static IP to manually configure the network settings.	Static IP DHCP
IP Address	Assign an IP address.	192.168.0.104
Subnet Mask	Specify the subnet mask.	255.255.255.0
Gateway	Specify the default gateway.	192.168.0.1
Primary DNS	Specify the primary DNS. Note: This function is not supported.	-
Secondary DNS	Specify the secondary DNS. Note: This function is not supported.	-

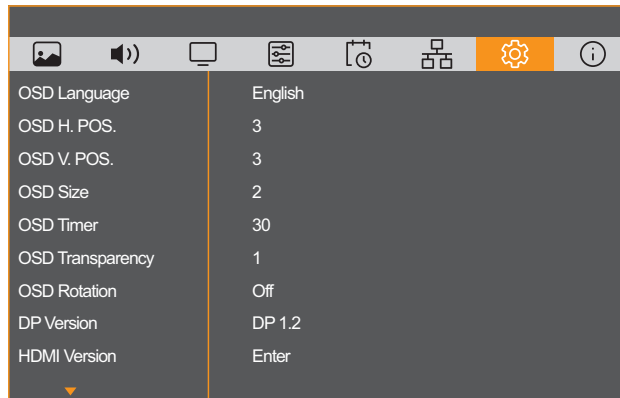

ADJUSTING THE LCD DISPLAY

4.7 System Settings



Item	Function	Range
OSD Language	Set the OSD language. EN(English) / 繁中(繁體中文) / FR(French) / DE(Deutsch) / ES(Español) / IT(Italiano) / PT(Portugal) / RO(Romania) / PL(Polski) / CS(Čeština) / NL(Dutch) / JP(Japanese) / RU(Русский)	EN 繁中 FR DE ES IT PT RO PL CS NL JP RU
OSD H. POS.	Move the OSD window to the left or right of the screen.	1 2 3 4 5
OSD V. POS.	Move the OSD window up or down the screen.	1 2 3 4 5
OSD Size	Adjust the OSD window size.	1 2
OSD Timer	Set the length of time (in seconds) the OSD screen is displayed. When the time elapses, the OSD screen is automatically inactivated.	Off 10 30 60

ADJUSTING THE LCD DISPLAY

Item	Function	Range
OSD Transparency	Adjust the transparency level of the OSD screen.	1 2 3 4 5
OSD Rotation	Rotate the OSD menu on the screen to match the LCD display's position.	Off 90° 180°
DP Version	Set the DP version to 1.1 or 1.2. Note: This option is disabled when DP Output is active.	DP 1.1 DP 1.2
HDMI Version	Set the HDMI version to 1.4 or 2.0. Note: This option is available only for HDMI 1 or HDMI 2 inputs and is unavailable when DP Output is active.	HDMI 1.4 HDMI 2.0
Colour Range	Set the RGB input signal range. Note: This menu item supports only the RGB color space for HDMI input.	Auto Full Limit
LED Indicator	Set the display LED indicator on or off.	Off On
ECO Smart Sensor	Set the ECO Smart sensor on or off. Note: Enabling this feature will automatically disable the Sync Dimming function.	Off On
Logo	Enable or disable displaying the picture of Logo when you turn on your LCD display.	Off On
Key Lock	Enable or disable some or all control panel buttons. <ul style="list-style-type: none"> • Off: Unlock all control panel buttons. • Lock Except Power: Lock all control panel buttons except for the Power button. • Lock All: Lock all control panel buttons. Note: To unlock all the buttons, you can also press the  Source button on the control panel for 5 seconds.	Off Lock Except Power Lock All
IR Lock	Enable or disable some or all remote control buttons. <ul style="list-style-type: none"> • Off: Unlock all remote control buttons. • Lock Except Power: Lock all remote control buttons except for the Power button. • Lock All: Lock all remote control buttons. Note: To unlock all the buttons, you can also press the  button on the remote control for 5 seconds.	Off Lock Except Power Lock All
Message Display	Show or hide on-screen messages.	Off On
USB FW Update	This function is reserved for maintenance personnel.	-
DDC/CI	Enable this feature to activate the DDC/CI protocol to allow users to configure the monitor by a software. Note: This function is not supported.	-

ADJUSTING THE LCD DISPLAY

Item	Function	Range
Switch On State	<p>Select the display status used for the next time you connect the power cord.</p> <ul style="list-style-type: none"> • Last status: The display will return to the previous power status (on/off) when removing and replacing the power cord. • Force on: The display will turn on when the power cord is connected to a wall outlet. • Keep off: The display will remain off when the power cord is connected to a wall outlet. 	Last Status Force On Keep Off
Standby	<p>Set standby mode when the display does not detect any input signal.</p> <ul style="list-style-type: none"> • Normal: The display can wake up when it detects a signal after standby. • Eco: The display cannot wake up when it detects a signal after standby. (LAN and Hotkey control device are not fully supported.) • Off: The display does not enter standby mode when there is no signal. 	Normal Eco Off
Wake On LAN	<p>Enables or disables turning on the display over network.</p> <p>Note: The default setting is Off.</p>	Off On
User Profiles	<p>Save As: Save the customized settings for specific user.</p>	User 1 User 2 User 3 User 4 User 5
	<p>Load As: Load the saved settings for specific user.</p>	User 1 User 2 User 3 User 4 User 5
Factory Reset	<p>Reset all settings to the factory preset values.</p>	Yes No

ADJUSTING THE LCD DISPLAY

4.8 Information



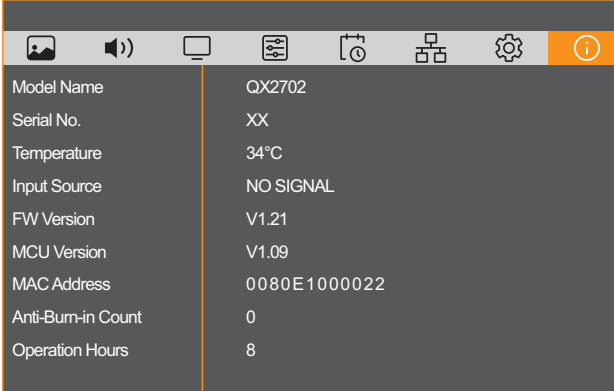







View the information about your LCD display.

A screenshot of a device's LCD display showing a menu of system information. At the top, there is a navigation bar with several icons: a picture, a speaker, a monitor, a calendar, a power button, a network icon, a gear, and an information icon (highlighted in orange). Below the navigation bar, the information is presented in a two-column list. The left column contains labels for various system metrics, and the right column contains their corresponding values.

Model Name	QX2702
Serial No.	XX
Temperature	34°C
Input Source	NO SIGNAL
FW Version	V1.21
MCU Version	V1.09
MAC Address	0080E1000022
Anti-Burn-in Count	0
Operation Hours	8

CHAPTER 5: APPENDIX

5.1 Warning Messages

Warning Messages	Cause	Solution
 INPUT SIGNAL OUT OF RANGE	The resolution or the refresh rate of the graphics card of the computer is set too high.	<ul style="list-style-type: none"> Change the resolution or the refresh rate of the graphics card.
 NO SIGNAL  NO CABLE	The LCD display cannot detect the input source signal and enters the Standby mode.	<ul style="list-style-type: none"> Check if the input source is turned ON. Check if the signal cable is properly connected. Check if any pin inside the cable connector is twisted or broken.
 KEYS LOCKED	The operation using the control panel buttons has been locked by the user.	<ul style="list-style-type: none"> Disable the key lock function in System Settings > Key Lock menu or press the  button for 5 seconds. Refer to pages 35.
 RC LOCKED	<p>The operation using the remote control buttons has been locked by the user.</p> <p>The Remote control battery is dead.</p>	<ul style="list-style-type: none"> Disable the IR lock function in System Setting > IR Lock menu or press the  button for 5 seconds. Refer to pages 35.
 ANTI-BURN-IN ON	The Anti-Burn-in™ function has been enabled by the user.	<ul style="list-style-type: none"> Disable the Anti-Burn-in™ function. Refer to pages 29.
 WARNING CHANGING SETTINGS IN OSD MENU MAY INCREASE THE POWER CONSUMPTION OF YOUR MONITOR. DO YOU WANT TO CONTINUE TO CHANGE? <input type="button" value="ACCEPT"/> <input type="button" value="CANCEL"/>	This warning message box will only show when the menu feature setting is changed for the first time.	<ul style="list-style-type: none"> Select ACCEPT to continue the setting changes, or select CANCEL to disable the setting changes.
 OVERHEAT WARNING SHUTTING DOWN IN 30 SECONDS DUE TO HIGH INTERNAL TEMPERATURE.  TEMPERATURE WARNING HIGH TEMPERATURE DETECTED, BRIGHTNESS REDUCED TO PREVENT OVERHEATING.	<p>A temperature warning message will appear on the screen when the temperature reaches 60°C (140°F). Over heat Warning Message and Reduce backlight 50%</p> <p>The device will shut down automatically when the internal temperature reaches 65°C (149°F).</p>	<ul style="list-style-type: none"> Make sure the ventilation slots of the LCD display are not obstructed. Make sure the room temperature is between 0°C to 40°C (32°F to 104°F).

APPENDIX

5.2 Supported Resolutions

No.	Mode	Resolution	Vertical Pixel (Hz)
1	VGA	640 x 480	60
2	VGA	640 x 480	75
3	SVGA	800 x 600	60
4	SVGA	800 x 600	75
5	XGA	1024 x 768	60
6	XGA	1024 x 768	75
7	NEC A	1280 x 1024	70
8	NEW	1280 x 1024	72
9	SVGA	1280 x 1024	75
10	SVGA	1280 x 720p	60
11	HD 1080	1920 x 1080	60
12	UHD	3840 x 2160	30
13	UHD	3840 x 2160	60

APPENDIX

5.3 Troubleshooting

Symptom	Possible Cause	Remedy
No picture is displayed	<ul style="list-style-type: none"> The power cord has been disconnected. The main power switch on the back of the display is not switched on. The selected input has no connection. The display is in standby mode. 	<ol style="list-style-type: none"> 1 Plug in the power cord. 2 Make sure the power switch is switched on. 3 Connect a signal connection to the display.
Interference displayed on the display or audible noise is heard	Caused by surrounding electrical appliances or fluorescent lights.	Move the display to another location to see if the interference is reduced.
Colour is abnormal	The signal cable is not connected properly.	Make sure that the signal cable is attached firmly to the back of the display.
Picture is distorted with abnormal patterns	<ul style="list-style-type: none"> The signal cable is not connected properly. The input signal is beyond the capabilities of the display. 	<ul style="list-style-type: none"> Make sure that the signal cable is attached firmly. Check the video signal source to see if it is beyond the range of the display. Please verify its specifications with this display's specification section.
Display image doesn't fill up the full size of the screen	The picture format is not set correctly.	Press the 16:9 button and select a suitable picture format.
Can hear sound, but no picture	Improperly connected source signal cable.	Make sure that both video inputs and sound inputs are correctly connected.
Can see picture but no sound is heard	<ul style="list-style-type: none"> Improperly connected source signal cable. Volume is turned all the way down. MUTE function is turned on. No external speaker connected. 	<ul style="list-style-type: none"> Make sure that both video and sound inputs are correctly connected. Press the VOL^+ or VOL^- button to hear the sound. Switch the MUTE function off by using the  button. Connect the external speakers and adjust the volume to a suitable level.
Some picture elements do not light up	Some pixels of the display may not turn on.	This display is manufactured using an extremely high level of precision technology: however, sometimes some pixels of the display may not display. This is not a malfunction.
After-Images can still be seen on the display after the display is powered off. (Examples of still pictures include logos, video games, computer images, and images displayed in 4:3 normal mode)	A still picture is displayed for an over extended period of time.	Do not allow a still image to be displayed for an extended period of time as this can cause a permanent after-image to remain on the display.

CHAPTER 6: SPECIFICATIONS

6.1 Display Specifications

		QX2702
Panel	Panel Type	LED-Backlit TFT LCD (VA Technology)
	Panel Size	27.0"
	Max. Resolution	UHD 3840 x 2160
	Pixel Pitch	0.155 mm
	Brightness	400 cd/m ²
	Contrast Ratio	1000:1
	Viewing Angle (H/V)	178°/178°
	Display Colour	1.07B
	Response Time	5 ms
Frequency (H/V)	Frequency (H)	30 kHz-160 KHz
	Frequency (V)	30 Hz-76 Hz
Input	DisplayPort	1.2 x 1
	HDMI	2.0 x 4
Output	DisplayPort	1.2 x 1
External Control	RS232 In	2.5 mm Phone Jack
	RS232 out	2.5 mm Phone Jack
	LAN	RJ45 x 1
	IR In	3.5 mm Phone Jack
	IR Out	3.5 mm Phone Jack
Other Connectivity	USB	2.0 x 1 (Service Port)
Audio	Audio Out	Stereo Audio Jack (3.5 mm)
	Internal Speakers	10W x 2
Power	Power Supply	External
	Power Requirements	DC 24V, 5.5A
	On Mode	33W (On)
	Standby Mode	< 0.5W
	Off Mode	< 0.3 W
Glass	Surface Treatment	AG
	Thickness	3.2 mm (0.13")
	Gloss	75±10%
	Haze	3-8%
	MOHS Hardness	6
	Pencil Hardness	8H
	IK Rating	IK08
Durability and Protection	IK Rating	IK10 (Metal casing)
Operating Conditions	Temperature	0°C-40°C (32°F-104°F)
	Humidity	10%-90% (non-condensing)
Storage Conditions	Temperature	-20°C-60°C (-4°F-140°F)
	Humidity	5%-95% (non-condensing)
Mounting	VESA FPMPI	Yes (100 x 100 mm)
Security	Kensington Security Slot	Yes
Dimensions	Bezel Width	Even bezel 12.8 mm
	Product w/o Base (W x H x D)	653.2 x 392.0 x 57.0 mm (25.7" x 15.4" x 2.2")
	Packaging (W x H x D)	750.0 x 485.0 x 140.0 mm (29.5" x 19.0" x 5.5")
Weight	Product w/o Base	7.93 kg (17.5 lb)
	Packaging	10.2 kg (22.5 lb)

Note:

- ◆ All specifications are subject to change without prior notice.

SPECIFICATIONS

6.2 Display Dimensions

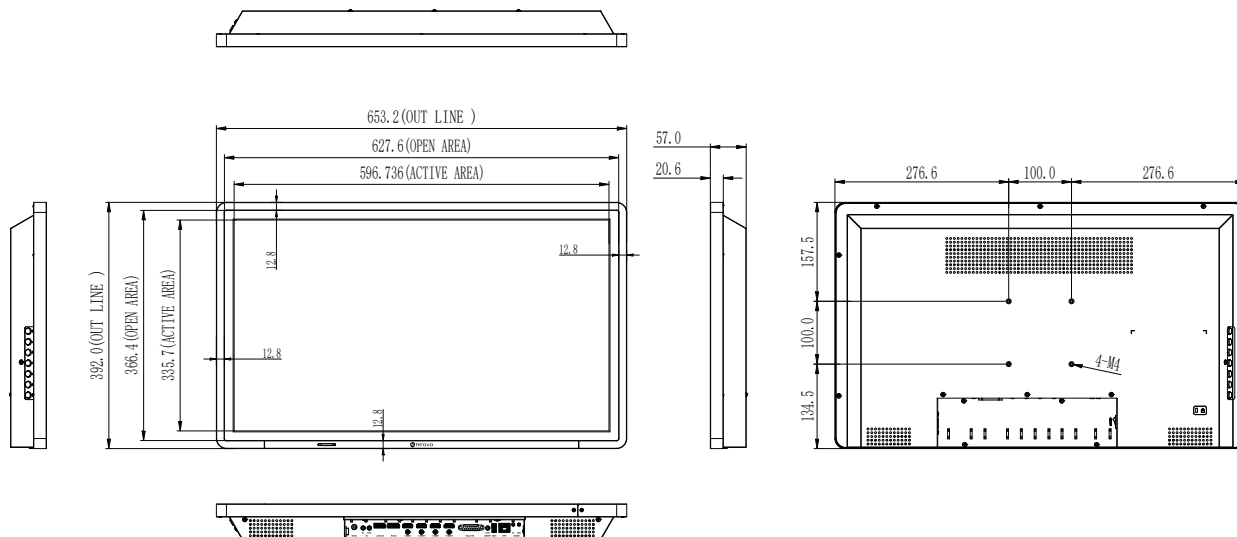

AG Neovo

Company Address: 5F-1, No. 3-1, Park Street, Nangang District, Taipei, 11503, Taiwan.

Copyright © 2026 AG Neovo. All rights reserved.

QX2702 Eprel registration number: 2438052

QX2720_UM_V011