



THE DISPLAY CHOICE
OF PROFESSIONALS™

www.agneovo.com

LW2204 LCD Monitor
User Manual

TABLE OF CONTENTS

SAFETY INFORMATION

WEEE	3
------------	---

PRECAUTIONS

Notice	4
Cautions When Setting Up	4
Cautions When Using	5
Cleaning and Maintenance	6
Notice for the LCD Monitor	6

CHAPTER 1: PRODUCT DESCRIPTION

1.1 Package Contents	7
1.2 Installation	8
1.2.1 Installing the Stand	8
1.2.2 Adjusting the Tilt	8
1.2.3 Wall Mounting	9
1.3 Overview	10
1.3.1 Front View	10
1.3.2 Control Buttons	11
1.3.3 Rear View	13

CHAPTER 2: MAKING CONNECTIONS

2.1 Connecting the AC Power	14
2.2 Connecting Input Source Signals	15
2.3 Connecting Audio Devices	16

CHAPTER 3: ON SCREEN DISPLAY MENU

3.1 Using the OSD Menu	17
3.2 OSD Menu Tree	18

CHAPTER 4: ADJUSTING THE LCD MONITOR

4.1 Colour Setting	20
4.2 Picture Setting	21
4.3 OSD Setting	22
4.4 Other Setting	23

CHAPTER 5: APPENDIX

5.1 Warning Messages	24
5.2 Troubleshooting	25
5.3 Transporting the LCD Monitor	26

CHAPTER 6: SPECIFICATIONS

6.1 Monitor Specifications	28
6.2 Monitor Dimensions	29

SAFETY INFORMATION

WEEE

Disposal of Waste Equipment by Users in Private Household in the European Union.

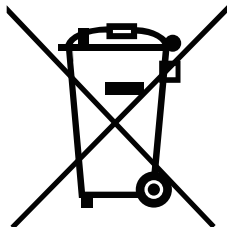

This symbol on the product or on its packaging indicates that this product must not be disposed of with your other household waste. Instead, it is your responsibility to dispose of your waste equipment by handing it over to a designated collection point for the recycling of waste electrical and electronic equipment. The separate collection and recycling of your waste equipment at the time of disposal will help to conserve natural resources and ensure that it is recycled in a manner that protects human health and the environment. For more information about where you can drop off your waste equipment for recycling, please contact your local city office, your household waste disposal service or the shop where you purchased the product

For Private Households in the European Union. To help conserve natural resources and ensure the product is recycled in a manner that protects human health and the environment, we would like to bring your attention to the following:

- The crossed-out dustbin on the device or outer packaging indicates the product is compliant with European WEEE (Waste Electrical and Electronic Equipment) Directive
- Always dispose of the old devices separately from household waste
- Batteries should be removed beforehand and disposed separately to the right collection system
- You are responsible with regard to the deletion of personal data on old devices before disposal
- Private households can hand in their old devices free of charge
- For more information about where you can drop off your waste equipment for recycling, please contact your local city office, your household waste disposal service or the shop where you purchased the product

PRECAUTIONS

PRECAUTIONS

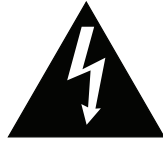

CAUTION
RISK OF ELECTRIC SHOCK
DO NOT OPEN



Symbols used in this manual



This icon indicates the existence of a potential hazard that could result in personal injury or damage to the product.



This icon indicates important operating and servicing information.

Notice

- Read this User Manual carefully before using the LCD monitor and keep it for future reference.
- The product specifications and other information provided in this User Manual are for reference only. All information is subject to change without notice. Updated content can be downloaded from our web site at www.agneovo.com.
- To protect your rights as a consumer, do not remove any stickers from the LCD monitor. Doing so may affect the determination of the warranty period.

Cautions When Setting Up



Do not place the LCD monitor near heat sources, such as a heater, exhaust vent, or in direct sunlight.



Do not cover or block the ventilation holes in the housing.



Place the LCD monitor on a stable area. Do not place the LCD monitor where it may be subject to vibration or shock.



Place the LCD monitor in a well-ventilated area.



Do not place the LCD monitor outdoors.



Do not place the LCD monitor in a dusty or humid environment.



Do not spill liquid or insert sharp objects into the LCD monitor through the ventilation holes. Doing so may cause accidental fire, electric shock or damage the LCD monitor.

PRECAUTIONS

Cautions When Using



Use only the power cord supplied with the LCD monitor.



The power outlet should be installed near the LCD monitor and be easily accessible.



If an extension cord is used with the LCD monitor, ensure that the total current consumption plugged into the power outlet does not exceed the ampere rating.



Do not allow anything to rest on the power cord. Do not place the LCD monitor where the power cord may be stepped on.



If the LCD monitor will not be used for an indefinite period of time, unplug the power cord from the power outlet.



To disconnect the power cord, grasp and pull by the plug head. Do not tug on the cord; doing so may cause fire or electric shock.



Do not unplug or touch the power cord with wet hands.



WARNING:

Unplug the power cord from the power outlet and refer to qualified service personnel under the following conditions:



- When the power cord is damaged.
- If the LCD monitor has been dropped or the housing has been damaged.
- If the LCD monitor emits smoke or a distinct odor.



Ceiling mount or mount on any other horizontal surface overhead are not advisable.



WARNING:

Installation in contravention of the instructions may result in undesirable consequences, particularly hurting people and damaging property. Users who have already mounted the monitor on the ceiling or any other horizontal surface overhead are strongly advised to contact AG Neovo for consultations and solutions to help ensure a most pleasurable and fulfilling monitor experience.

PRECAUTIONS

Cleaning and Maintenance



Do not attempt to service the LCD monitor yourself, refer to qualified service personnel.

Opening or removing the covers may expose you to dangerous voltage or other risks.

Notice for the LCD Monitor

In order to maintain the stable luminous performance, it is recommended to use low brightness setting.

Due to the lifespan of the lamp, it is normal that the brightness quality of the LCD monitor may decrease with time.

When static images are displayed for long periods of time, the image may cause an imprint on the LCD monitor. This is called image retention or burn-in.

To prevent image retention, do any of the following:

- Set the LCD monitor to turn off after a few minutes of being idle.
- Use a screen saver that has moving graphics or a blank white image.
- Switch desktop backgrounds regularly.
- Adjust the LCD monitor to low brightness settings.
- Turn off the LCD monitor when the system is not in use.

Things to do when the LCD monitor shows image retention:

- Turn off the LCD monitor for extended periods of time. It can be several hours or several days.
 - Use a screen saver and run it for extended periods of time.
 - Use a black and white image and run it for extended periods of time.
-

There are millions of micro transistors inside the LCD monitor. It is normal for a few transistors to be damaged and to produce spots. This is acceptable and is not considered a failure.

CHAPTER 1: PRODUCT DESCRIPTION

1.1 Package Contents

When unpacking, check if the following items are included in the package. If any of them is missing or damaged, contact your dealer.

LCD Monitor

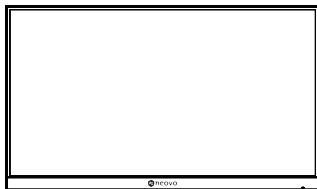

Base Mount



Stand

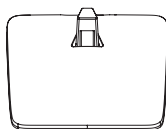

Quick Start Guide

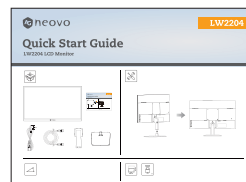

HDMI Cable

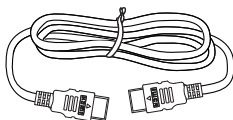

Power cord



Note:

- Use only the supplied power cord.
- The above pictures are for reference only. Actual items may vary upon shipment.

PRODUCT DESCRIPTION

1.2 Installation

1.2.1 Installing the Stand

1. Place the LCD monitor with the screen side down on a cushioned surface.
2. Attach the stand to the LCD monitor.
 - a. Install the base mount to its compartment on the monitor.
 - b. Attach the stand to the base mount.

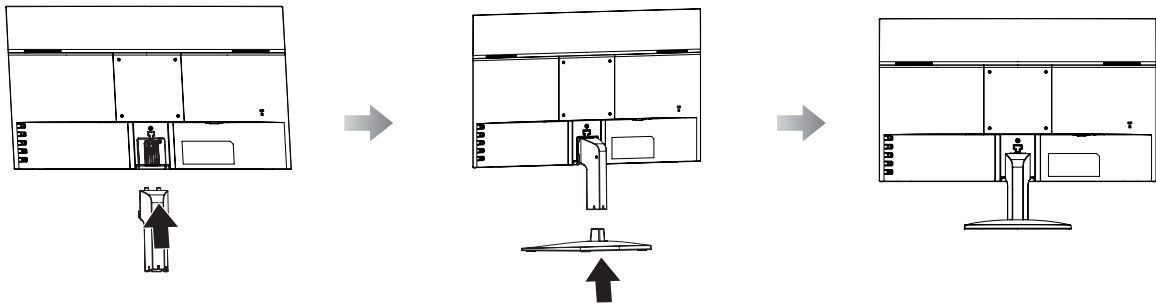

1.2.2 Adjusting the Tilt

For comfort viewing, tilt the LCD monitor up to an angle of -5° ~ 20° . Hold the stand with one hand and use the other to adjust the LCD monitor to the desired angle.

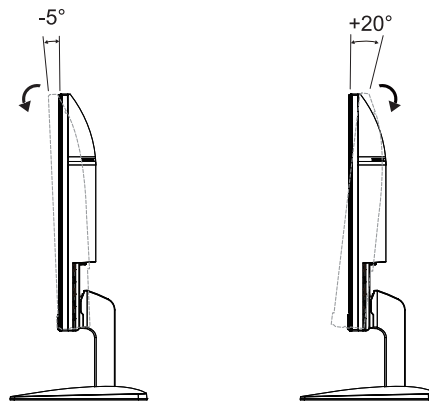

PRODUCT DESCRIPTION

1.2.3 Wall Mounting

To wall mount the LCD monitor, do the following steps:

1. Remove the stand.

Please refer to page 27.

2. Wall mount the LCD monitor.

Screw the mounting bracket to the VESA holes at the rear of the LCD monitor.

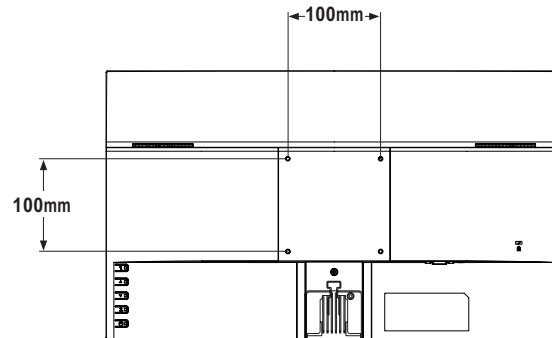

Note: Take measures to prevent the LCD monitor from falling down and lessen possible injury and damage to the monitor in case of earthquakes or other disasters.

- Use only the 100 x 100 mm wall mount kit recommended by AG Neovo. All AG Neovo wall mount kits comply with VESA standard.
- Secure the LCD monitor on a solid wall strong enough to bear its weight.
- It is suggested to wall mount the LCD monitor without tilting it facing downward.

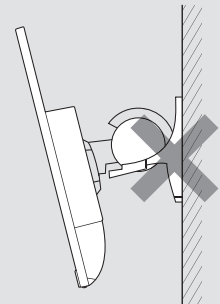

PRODUCT DESCRIPTION

1.3 Overview

1.3.1 Front View

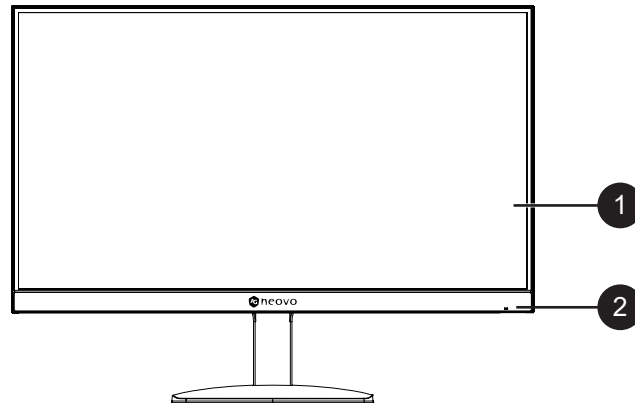

1

Monitor screen

2

Power status indicator:



Indicates the operating status of the display:

- Lights Blue when the display is turned on.
- Lights amber when the display is in standby mode.
- Lights off when the main power of the display is turned off..

PRODUCT DESCRIPTION

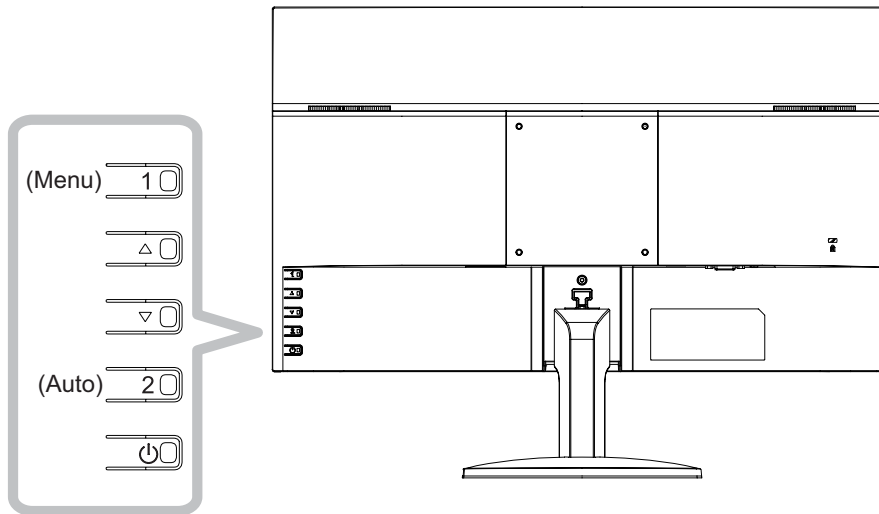
1.3.2 Control Buttons

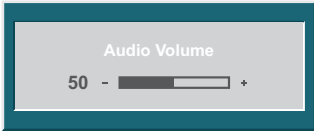

Button	Description
Menu Button (1)	<p>On Screen Display (OSD)</p> <ul style="list-style-type: none"> Press to call out the OSD menu. <p>During OSD menu</p> <ul style="list-style-type: none"> Use to confirm the selection or enter a submenu.
Up / Down Button (▲/▼)	<p>Volume Bar</p> <ul style="list-style-type: none"> Press the ▲ button to call out the volume bar.  <p>Then press the ▲/▼ button to adjust the volume level.</p> <p>Note: During volume or menu setting adjustment, press and hold the ▲/▼ button to change the values continuously.</p> <p>Input Select Bar</p> <ul style="list-style-type: none"> Press the ▼ button to call out the Input Select bar.  <p>Then press the ▲/▼ button to switch the input source and press the 1(MENU) button to confirm.</p> <p>During OSD menu</p> <ul style="list-style-type: none"> Use to scroll through the menu options. Use to select an option and adjust the settings.

PRODUCT DESCRIPTION

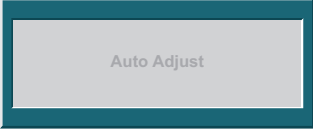
Button	Description
<p>Auto Button (2)</p>	<p>Auto Adjustment (available in VGA input only)</p> <p>Press to perform auto adjustment. This function automatically tunes the LCD monitor to its optimal setting, including horizontal position, vertical position, clock, and phase.</p> <p>When auto adjustment is initiated, the below message is displayed on the screen.</p> <div data-bbox="791 510 1104 640" style="text-align: center;"></div> <p>When the message disappears, this indicates the auto adjustment is completed.</p> <p>Note:</p> <ul style="list-style-type: none">• <i>During auto adjustment, the screen will slightly shake for a few seconds.</i>• <i>It is recommended to use the auto adjustment function when using the LCD monitor for the first time or after a resolution or frequency change.</i> <p>During OSD menu</p> <ul style="list-style-type: none">• Use to close the OSD menu or exit a submenu. <p>During audio volume adjustment</p> <ul style="list-style-type: none">• Use to close the audio volume bar.
<p>Power Button (⏻)</p>	<p>Power ON/OFF</p> <ul style="list-style-type: none">• Press once to turn the monitor ON.• Press again to turn the monitor OFF.

PRODUCT DESCRIPTION

1.3.3 Rear View

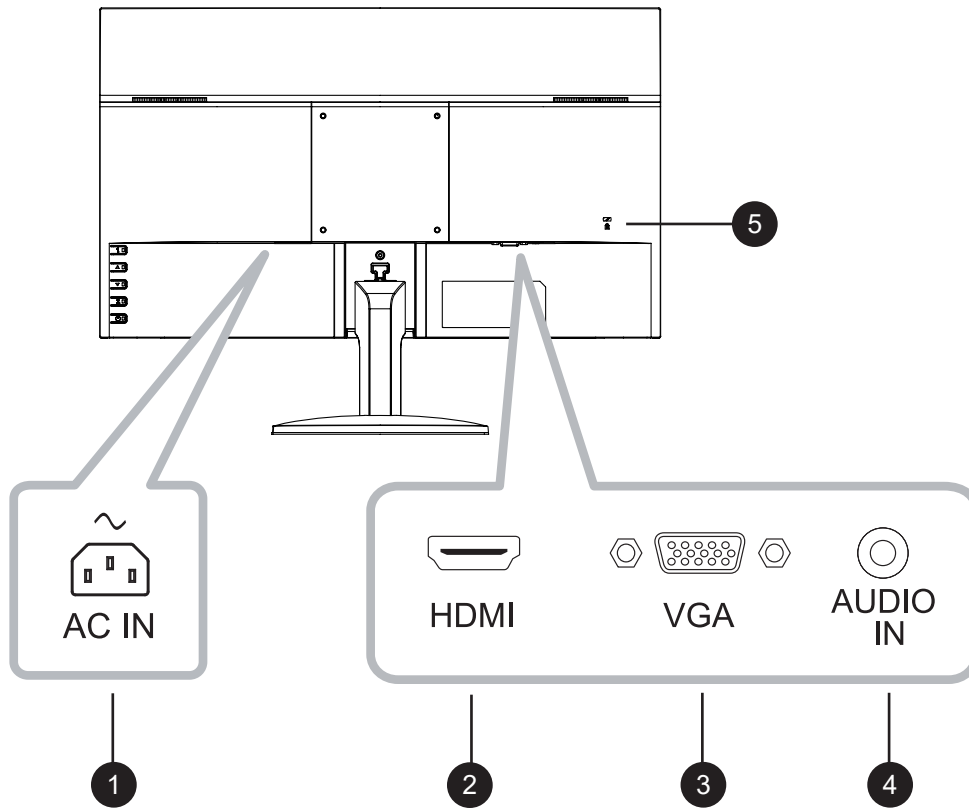

1

AC IN

AC power input.

2

HDMI

Connect HDMI signals input.

3

VGA

Connect VGA signals input.

4

AUDIO IN

Connect audio signals input (3.5 mm Stereo Audio Jack).

5

Kensington lock socket

Use to physically lock the system to prevent theft.

The locking device is sold separately. To purchase, contact your retailer.

CHAPTER 2: MAKING CONNECTIONS



CAUTION:

Make sure that the LCD monitor is not connected to the power outlet before making any connections. Connecting cables while the power is ON may cause possible electric shock or personal injury.

2.1 Connecting the AC Power

1. Connect the power cord to the AC power input at the rear of the LCD monitor.
2. Connect the power cord plug to a power outlet or a power supply.

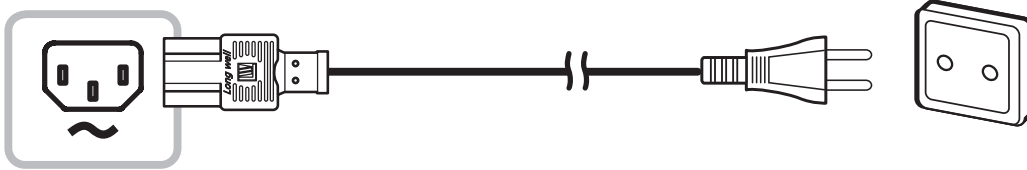

CAUTION:

When unplugging the power cord, hold the power cord by the plug head. Never pull by the cord.

MAKING CONNECTIONS

2.2 Connecting Input Source Signals

Input source signals can be connected with either of the following cables:

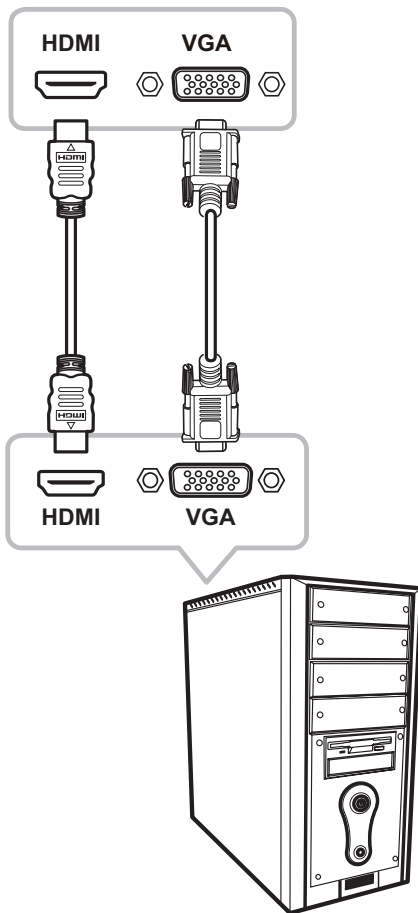

- **HDMI**

Connect one end of an HDMI cable to the HDMI connector of the LCD monitor and the other end to the HDMI connector of the computer.

- **VGA**

Connect one end of a D-sub 15-pin cable to the VGA connector of the LCD monitor and the other end to the D-sub connector of the computer.

MAKING CONNECTIONS

2.3 Connecting Audio Devices

- **Audio Input**

Connect one end of an audio cable to the audio port of the LCD monitor and the other end to the audio port of the computer.

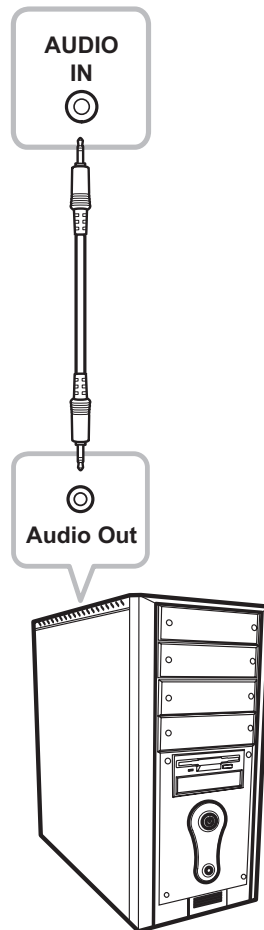

CHAPTER 3: ON SCREEN DISPLAY MENU

3.1 Using the OSD Menu

1. Press the 1 (MENU) button to call out the OSD window.

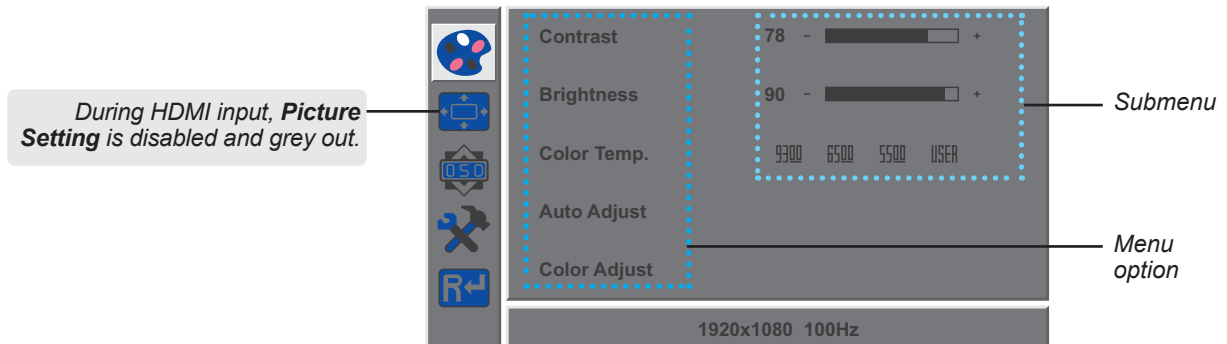

2. Press the ▲ or ▼ button to select a menu and press the 1 (MENU) button to enter the selected menu.

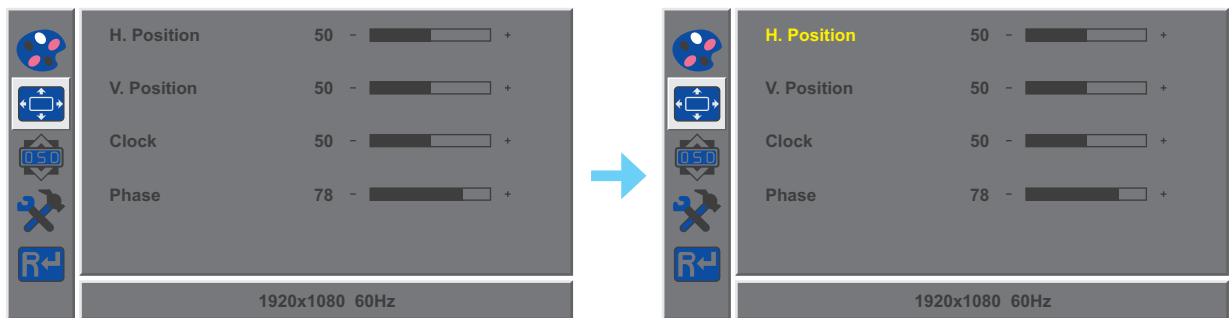

A selected menu is highlighted in grey and the text of the selected menu option turns yellow.

3. Press the ▲ or ▼ button to select an option and press the 1 (MENU) button to enter its submenu.

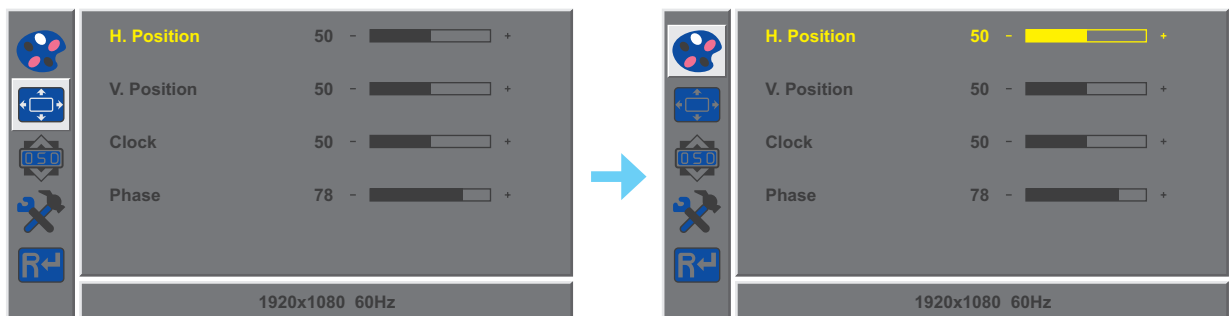

The text of the selected menu option or submenu turns yellow.

4. Press the ▲ or ▼ button to adjust the settings.
5. To exit the submenu, press the 2 (AUTO) button.
6. To close the OSD window, press the 2 (AUTO) button twice.

Note: When settings are modified, all changes are saved when the user does the following:

- Proceeds to another menu
- Exits the OSD menu
- Waits for the OSD menu to disappear

ON SCREEN DISPLAY MENU

3.2 OSD Menu Tree

Main Menu	Submenu		Reference
Colour	Contrast	0-100	Refer to page 20.
	Brightness	0-100	
	Color Temp.	9300	
		6500	
		5500	
		USER	
	Auto Adjust	only VGA	
Color Adjust	only VGA		
Picture	H. Position	0-100	Refer to page 21.
	V. Position	0-100	
	Clock	0-100	
	Phase	0-100	
OSD	Language	English	Refer to page 22.
		Français	
		Deutsch	
		Italiano	
		Русский	
		Spanish	
		Portuguese	
		日本語	
		한국어	
		繁體中文	
	简体中文		
	OSD H. Pos.	0-100	
	OSD V. Pos.	0-100	
	OSD Timer	5-60	
Transparency	0-100		

ON SCREEN DISPLAY MENU

Main Menu	Submenu		Reference
Other	Mode	PC	Refer to page 23.
		Game	
		Movie	
	Audio Volume	0-100	
	Signal Source	VGA	
		HDMI	
	Aspect Ratio	16:9	
		AUTO	
		4:3	
	Active Contrast	On	
		Off	
	Over Drive	On	
		Off	
	Anti Blue Light	0-100	
	Adaptive-Sync	On	
Off			
Reset	Reset		Refer to page 24.

Note: Availability of some menu items depend on the input source signal. If the 1 (MENU) is not available, it is disabled and greyed out.

CHAPTER 4: ADJUSTING THE LCD DISPLAY

4.1 Colour Setting

1. Press the 1 (MENU) button to call out the OSD window.
2. Press the ▲ or ▼ button to select  and press the 1 (MENU) button to enter the Colour menu.

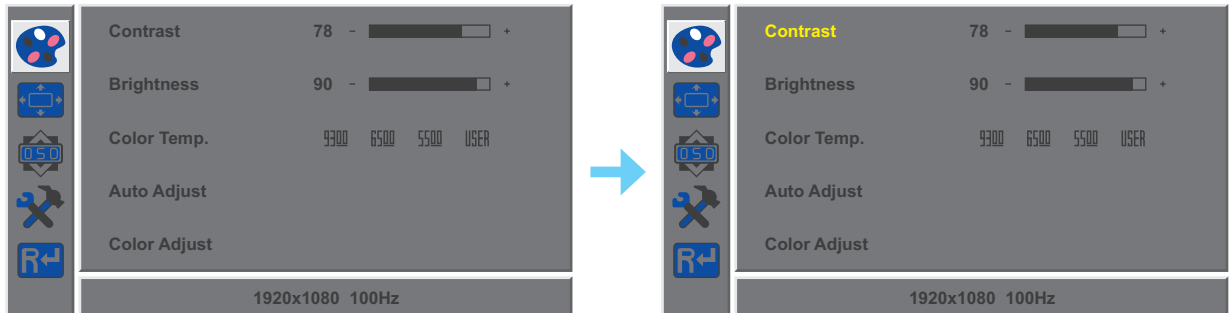

3. Press the ▲ or ▼ button to select an option and press the 1 (MENU) button to enter its submenu.

Item	Function	Operation	Range
Contrast	Adjusts the difference between the black level and the white level.	Press the ▲ or ▼ button to adjust the value.	0 to 100
Brightness	Adjusts the luminance of the screen image.		
Color Temp. (Colour Temperature)	Provides several colour adjustment settings.	Press the ▲ or ▼ button to select the setting.	9300 6500 5500 USER
	Colour temperature can be set to: <ul style="list-style-type: none"> • 9300 - Applies a bluish tint for cooler colours. • 6500 - This is the default colour temperature commonly used for normal lighting conditions. • 5500 - Applies a reddish tint for warmer colours. • USER - This allows users to set the colour temperature by adjusting the red, green, or blue setting according to one's preference. <ol style="list-style-type: none"> a. Select USER and press the 1 (MENU) button. b. Press the ▲ or ▼ button to select the colour you want to adjust. Then press the 1 (MENU) button to enter its submenu. c. Press the ▲ or ▼ button to adjust the value (0 ~ 255). Note: Activate Reset to return the colour to its default setting.		
Auto Adjust	Automatically optimises image display.	Press the 1 (MENU) button to execute the function.	-
Color Adjust	Operates the white balance and automatically adjusts the colour settings.		-
	Note: This menu option is only available if the input source is VGA.		

ADJUSTING THE LCD DISPLAY

4.2 Picture Setting

Note: This menu is only available if the input source is VGA.

1. Press the 1 (MENU) button to call out the OSD window.
2. Press the ▲ or ▼ button to select  and press the 1 (MENU) button to enter the Picture menu.

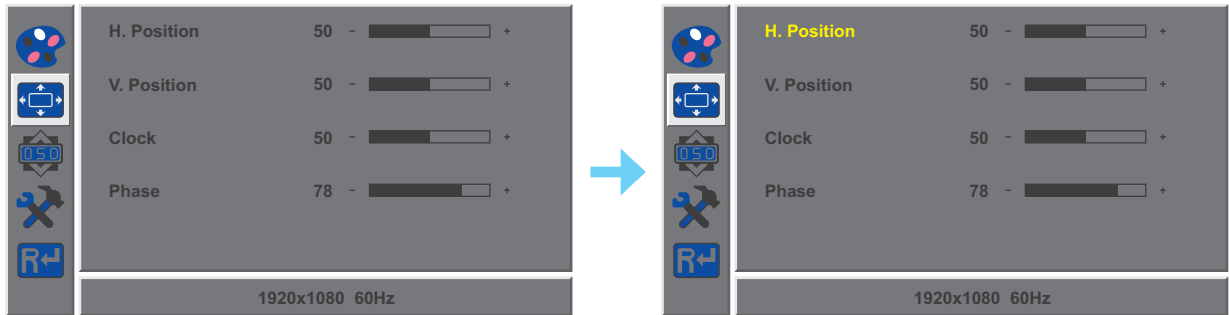

3. Press the ▲ or ▼ button to select an option and press the 1 (MENU) button to enter its submenu.

Item	Function	Operation	Range
H. Position (Horizontal Position)	Moves the screen image to the left or right.	Press the ▲ or ▼ button to adjust the value.	0 to 100
V. Position (Vertical Position)	Moves the screen image up or down.		
Clock	Adjusts the frequency timing to synchronise with the video signal.		
Phase	Adjusts the phase timing to synchronise with the video signal.		

ADJUSTING THE LCD DISPLAY

4.3 OSD Setting

1. Press the 1 (MENU) button to call out the OSD window.
2. Press the ▲ or ▼ button to select  and press the 1 (MENU) button to enter the OSD menu.

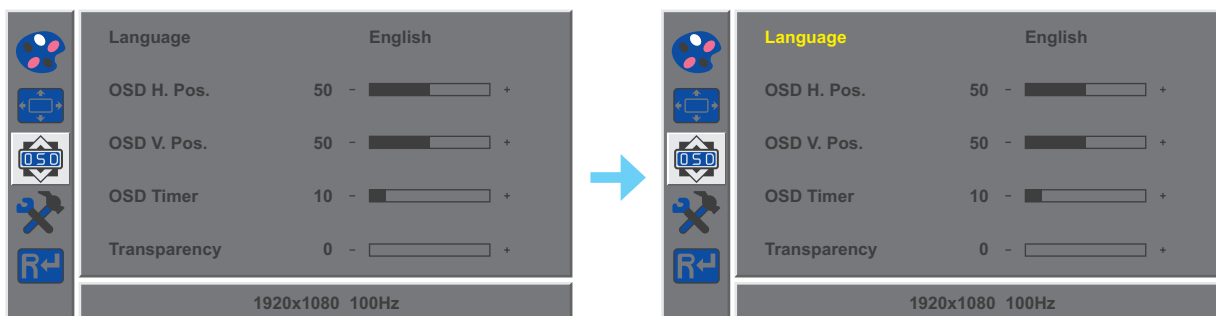

3. Press the ▲ or ▼ button to select an option and press the 1 (MENU) button to enter its submenu.

Item	Function	Operation	Range
Language	Choose the language used for OSD menus.	Press the ▲ or ▼ button to select the setting.	English Français Deutsch Italiano Русский Spanish Portuguese 日本語 한국어 繁體中文 简体中文
OSD H. Pos. (Horizontal Position)	Moves the OSD window to the left or right of the screen.	Press the ▲ or ▼ button to adjust the value.	0 to 100
OSD V. Pos. (Vertical Position)	Moves the OSD window up or down the screen.		
OSD Timer	Sets the length of time (in seconds) the OSD screen is displayed. When the time elapses, the OSD screen is automatically inactivated.		5 to 60
Transparency	Adjusts the transparency level of the OSD screen.		0 to 100

ADJUSTING THE LCD DISPLAY

4.4 Other Setting

1. Press the 1 (MENU) button to call out the OSD window.
2. Press the ▲ or ▼ button to select  and press the 1 (MENU) button to enter the Other menu.

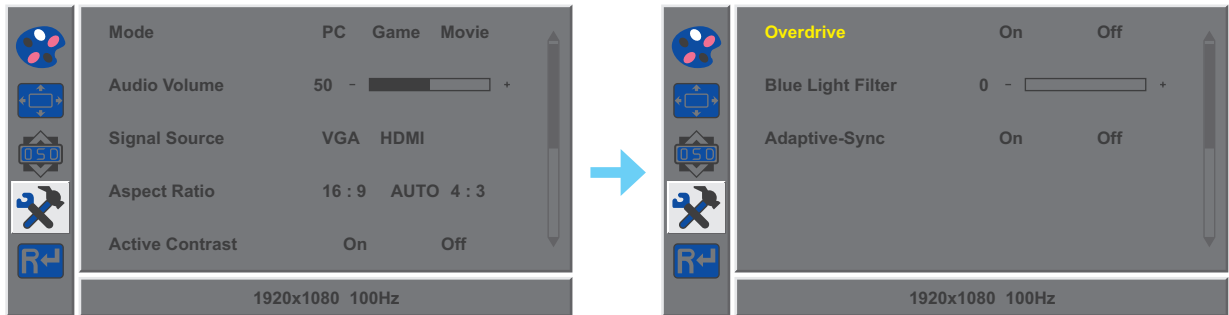

3. Press the ▲ or ▼ button to select an option and press the 1 (MENU) button to enter its submenu.

Item	Function	Operation	Range
Mode	Selects the display mode.	Press the ▲ or ▼ button to select the setting.	PC Game Movie
Audio Volume	Adjusts the volume level of the built-in speaker.	Press the ▲ or ▼ button to adjust the value.	0 to 100
Signal Source	Switches the input source.	Press the ▲ or ▼ button to select the setting.	VGA HDMI
Aspect Ratio	Selects the aspect ratio of the screen image.		16:9 AUTO 4:3
Active Contrast	Automatically adjusts the image contrast according to the scene. Note: If this function is On, Colour > Brightness/Contrast are grey out.		On Off
Over Drive	Enhance the monitor response time.		On Off
Anti Blue Light	Enables/Disables the blue light filter function. When enabled, it decreases the amount of blue light displayed on the screen, ensuring users a comfortable viewing experience by reducing eyestrain after long periods of use.		0 to 100
Adaptive sync	Support a variable refresh rate with the content's frame rate (only for HDMI)		On Off

ADJUSTING THE LCD DISPLAY

4.5 Reset Setting

1. Press the 1 (MENU) button to call out the OSD window.
2. Press the ▲ or ▼ button to select **R↵** and press the 1 (MENU) button to enter the Reset menu.

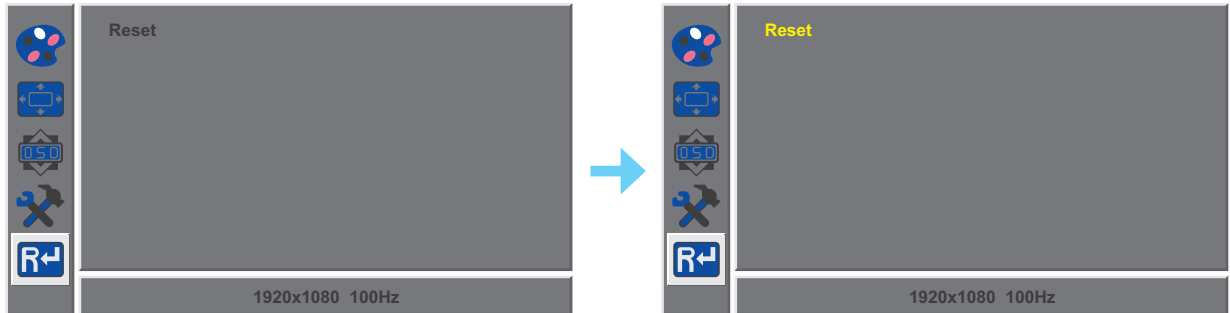

3. Press the 1 (MENU) button to restore your device to factory settings.

CHAPTER 5: APPENDIX

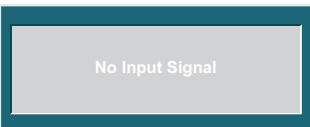
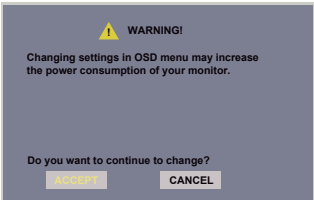

5.1 Warning Messages

When any of these warning messages appear, check the following items.

Warning Message	Cause	Solution
 <p>Out of range</p>	<p>The resolution or the refresh rate of the graphics card of the computer is set too high.</p>	<ul style="list-style-type: none"> √ Change the resolution or the refresh rate of the graphics card.
 <p>No Input Signal</p>	<p>The LCD monitor cannot detect the input source signal.</p>	<ul style="list-style-type: none"> √ Check if the input source is turned ON. √ Check if the signal cable is properly connected. √ Check if any pin inside the cable connector is twisted or broken.
 <p>WARNING! Changing settings in OSD menu may increase the power consumption of your monitor.</p> <p>Do you want to continue to change? [ACCEPT] [CANCEL]</p>	<p>This warning message box will only show when the menu feature setting is changed for the first time.</p>	<ul style="list-style-type: none"> • Press the ACCEPT button to continue the setting changes, or press the CANCEL button to disable the setting changes. • Note: The operation may vary from different product models.

APPENDIX

5.2 Troubleshooting

Problems	Possible Cause and Solution
<p>No picture.</p> <ul style="list-style-type: none"> • LED indicator is OFF. 	<ul style="list-style-type: none"> • Check if the LCD monitor is turned ON. • Check if the power cord is properly connected to the LCD monitor. • Check if the power cord is plugged into the power outlet.
<ul style="list-style-type: none"> • LED indicator is blue. 	<ul style="list-style-type: none"> • Check if the computer is turned ON. • Check if the computer is in standby mode, move the mouse or press any key to wake up the computer.
Image position is incorrect.	<ul style="list-style-type: none"> • For VGA input, adjust the H. Position and H. Position settings in Picture  menu (refer to page 21).
The displayed texts are blurry.	<ul style="list-style-type: none"> • For VGA input, do the following: <ul style="list-style-type: none"> √ Press the 2 (AUTO) button to auto-adjust the monitor (refer to “Auto Button (2)” on page 12). √ Adjust the Clock and Phase settings in Picture  menu (refer to page 21).
Red, blue, green, white dots appear on the screen.	<ul style="list-style-type: none"> • There are millions of micro transistors inside the LCD monitor. It is normal for a few transistors to be damaged and to produce spots. This is acceptable and is not considered a failure.
No audio output.	<ul style="list-style-type: none"> • Check if the Audio Volume is set to 0 (refer to page 11). • In Other  menu, check if the Audio Volume setting is set to 0 (refer to page 23). • For VGA input, check the audio setting of the computer.
Dew formed on the LCD monitor.	<ul style="list-style-type: none"> • This normally happens when the LCD monitor is moved from a cold room to a hot room temperature. Do not turn ON the LCD monitor, wait for the dew condensation to disappear.
Faint shadows from a static image appear on the screen.	<ul style="list-style-type: none"> • Turn off the LCD monitor for extended periods of time. • Use a screen saver or a black and white image and run it for extended periods of time.

APPENDIX

5.3 Transporting the LCD Monitor

To transport the LCD monitor for repair or shipment, place the monitor in its original packaging box.

1. Remove the stand.

- a. Place the LCD monitor with the screen side down on a cushioned surface.
- b. Press the latch(es) to detach the stand from the base mount. Then remove the stand.
- c. Press the latch to detach the base mount. Then remove the base mount from its compartment on the monitor.

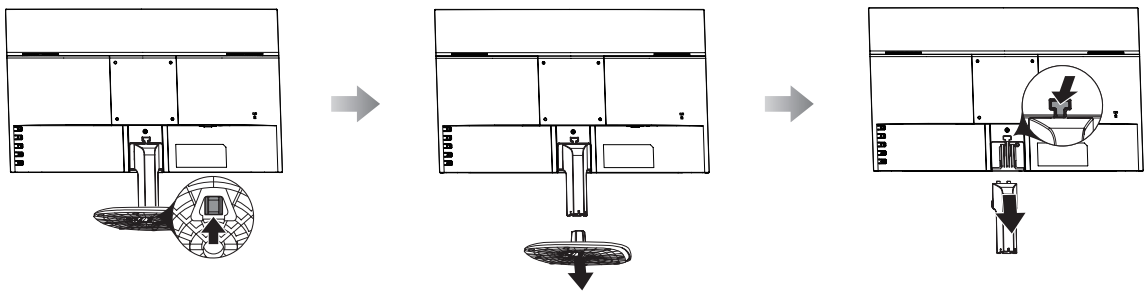

2. Put the LCD monitor inside its original plastic. Then place the LCD monitor into the lower foam cushion.

3. Place the upper foam cushion on the top of the LCD monitor.

4. Put all accessories on their designated area.

5. Carefully place the items into the box. Then close and tape the box.

APPENDIX

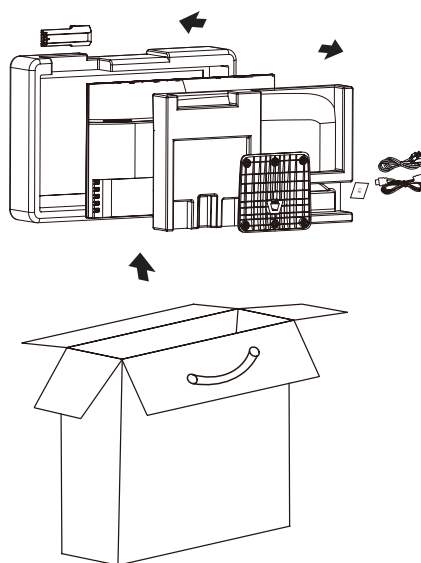

Note:

- *It is recommended to use the original packaging box.*
- *When repacking, carefully place the LCD monitor in its box and protect the glass panel from touching any object.*

CHAPTER 6: SPECIFICATIONS

6.1 Monitor Specifications

LW2204		
Panel	Panel Type	LED-Backlit TFT LCD (VA Technology)
	Panel Size	21.5"
	Max. Resolution	FHD 1920 x 1080
	Pixel Pitch	0.241 mm
	Brightness	250 cd/m ²
	Contrast Ratio	20,000,00:1 (DCR)
	Viewing Angle (H/V)	178°/178°
	Display Colour	16.7M
	Response Time	5 ms
	Surface Treatment	Anti-Glare Treatment (Haze 25%), 3H Hard Coating
Frequency (H/V)	H Freq.	30 kHz-113 kHz
	V Freq.	48 Hz-100 Hz
Input	VGA	15-Pin D-Sub x 1
	HDMI	1.4 x 1
Audio	Audio In	Stereo Audio Jack (3.5 mm)
	Speaker	2W x 2
Power	Power Supply	Internal
	Power Requirements	AC 100-240V, 50/60 Hz
	On Mode	16W (On)
	Standby Mode	< 0.5 W
	Off Mode	< 0.3 W
Operating Conditions	Temperature	0°C-40°C (32°F-104°F)
	Humidity	10%-90% (non-condensing)
Transport/ Storage Conditions	Temperature	-20°C-60°C (-4°F-140°F)
	Humidity	5%-90% (non-condensing)
Mounting	VESA FPMPI	Yes (100 x 100 mm)
Stand	Tilt	-5° to 20°
Security	Kensington Security Slot	Yes
Dimensions	Bezel Width	1.9 mm (Top/Left/Right) 21.4 mm (Bottom)
	Product with Base (W x H x D)	491.8 x 373.8 x 167.4 mm (19.4" x 14.7" x 6.6")
	Product w/o Base (W x H x D)	491.8 x 289.5 x 46.3 mm (19.4" x 11.4" x 1.8")
	Packaging (W x H x D)	562.0 x 375.0 x 110.0 mm (22.1" x 14.8" x 4.3")
Weight	Product with Base	2.6 kg (5.7 lb)
	Product w/o Base	2.3 kg (5.1 lb)
	Packaging	3.8 kg (8.4 lb)

Note: All specifications are subject to change without prior notice.

SPECIFICATIONS

6.2 Monitor Dimensions

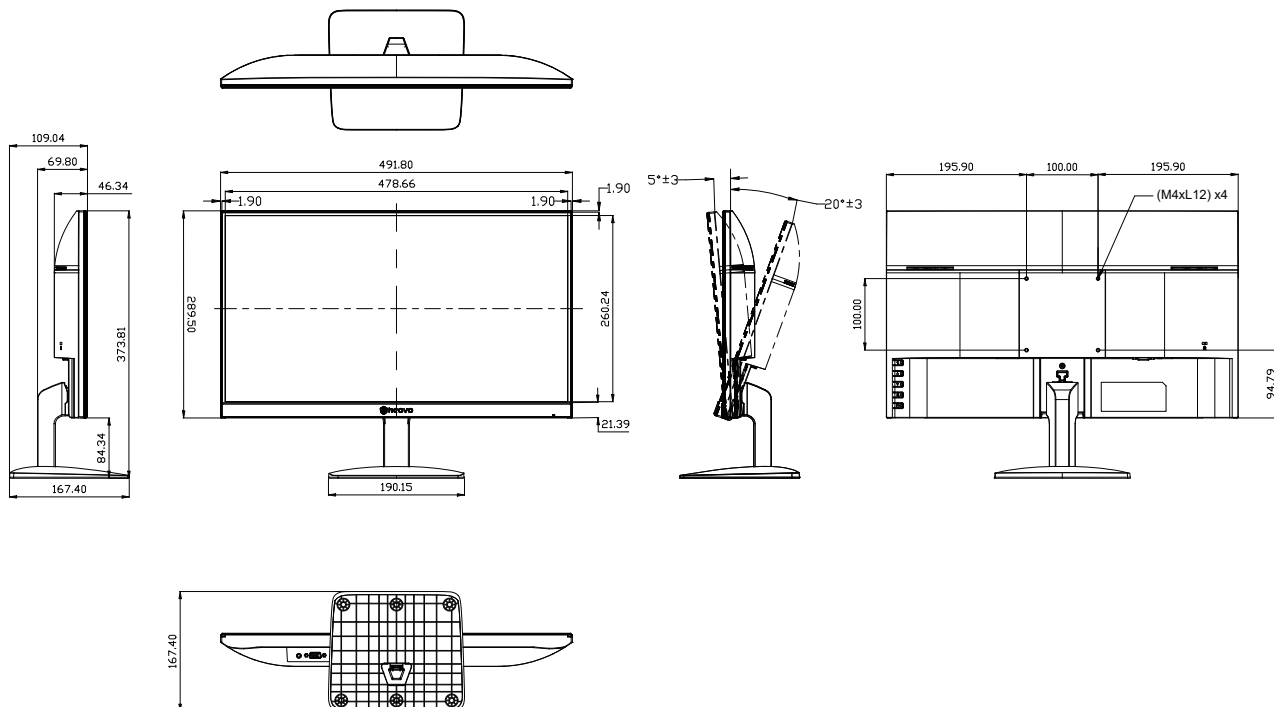

AG Neovo

Company Address: 5F-1, No. 3-1, Park Street, Nangang District, Taipei, 11503, Taiwan.

Copyright © 2026 AG Neovo. All rights reserved.

LW2204 Eprel registration number : 2662444

LW2204_UM_V010