



THE DISPLAY CHOICE  
OF PROFESSIONALS™

[www.agneovo.com](http://www.agneovo.com)

SC-2203 LCD Monitor  
**User Manual**

# TABLE OF CONTENTS

## SAFETY INFORMATION

WEEE .....	4
------------	---

## PRECAUTIONS

Notice .....	5
Cautions When Setting Up .....	5
Cautions When Using .....	6
Cleaning and Maintenance .....	7
Notice for the LCD Monitor .....	7

## CHAPTER 1: PRODUCT DESCRIPTION

1.1 Package Contents .....	8
1.2 Installation .....	9
1.2.1 Installing the Stand .....	10
1.2.2 Adjusting the Tilt .....	10
1.2.3 Wall Mounting .....	10
1.3 Overview .....	11
1.3.1 Front View .....	11
1.3.2 Control Panel .....	12
1.3.3 Rear View .....	13

## CHAPTER 2: MAKING CONNECTIONS

2.1 Connecting the AC Power .....	14
2.2 Connecting Input Source Signals .....	15
2.3 Connecting a Video Device .....	16

## CHAPTER 3: USING THE LCD MONITOR

3.1 Turning on the Power .....	17
3.2 Displaying the OSD Menu .....	18
3.3 Selecting a Source .....	19
3.4 Auto Adjusting the Screen (For VGA Source Only) .....	20
3.5 Locking the Control Keys .....	21

## CHAPTER 4: ON SCREEN DISPLAY MENU

4.1 Using the OSD Menu .....	22
4.2 OSD Menu Tree .....	23

## CHAPTER 5: ADJUSTING THE LCD MONITOR

5.1 VIDEO Menu .....	24
5.2 SETTING Menu .....	28
5.3 INFO Menu .....	31

## CHAPTER 6: APPENDIX

6.1 Warning Messages .....	32
6.2 Timing .....	33
6.3 Troubleshooting .....	34
6.4 Transporting the LCD Monitor .....	35

## CHAPTER 7: SPECIFICATIONS

# TABLE OF CONTENTS

7.1 Display Specifications .....	37
7.2 Display Dimensions.....	38

# SAFETY INFORMATION

## WEEE

Disposal of Waste Equipment by Users in Private Household in the European Union.

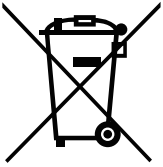

This symbol on the product or on its packaging indicates that this product must not be disposed of with your other household waste. Instead, it is your responsibility to dispose of your waste equipment by handing it over to a designated collection point for the recycling of waste electrical and electronic equipment. The separate collection and recycling of your waste equipment at the time of disposal will help to conserve natural resources and ensure that it is recycled in a manner that protects human health and the environment. For more information about where you can drop off your waste equipment for recycling, please contact your local city office, your household waste disposal service or the shop where you purchased the product.

For Private Households in the European Union. To help conserve natural resources and ensure the product is recycled in a manner that protects human health and the environment, we would like to bring your attention to the following:

- The crossed-out dustbin on the device or outer packaging indicates the product is compliant with European WEEE (Waste Electrical and Electronic Equipment) Directive
- Always dispose of the old devices separately from household waste
- Batteries should be removed beforehand and disposed separately to the right collection system
- You are responsible with regard to the deletion of personal data on old devices before disposal
- Private households can hand in their old devices free of charge
- For more information about where you can drop off your waste equipment for recycling, please contact your local city office, your household waste disposal service or the shop where you purchased the product

# PRECAUTIONS

## PRECAUTIONS



**CAUTION**  
RISK OF ELECTRIC SHOCK  
DO NOT OPEN



### Symbols used in this manual



This icon indicates the existence of a potential hazard that could result in personal injury or damage to the product.



This icon indicates important operating and servicing information.

## Notice

- Read this User Manual carefully before using the LCD monitor and keep it for future reference.
- The products specifications and other information provided in this User Manual are for reference only. All information is subject to change without notice. Updated content can be downloaded from our web site at [www.agneovo.com](http://www.agneovo.com).
- To protect your rights as a consumer, do not remove any stickers from the LCD monitor. Doing so may affect the determination of the warranty period.

## Cautions When Setting Up



Do not place the LCD monitor near heat sources, such as a heater, exhaust vent, or in direct sunlight.



Do not cover or block the ventilation holes in the housing.



Place the LCD monitor on a stable area. Do not place the LCD monitor where it may be subject to vibration or shock.



Place the LCD monitor in a well-ventilated area.



Do not place the LCD monitor outdoors.



Do not place the LCD monitor in a dusty or humid environment.



Do not spill liquid or insert sharp objects into the LCD monitor through the ventilation holes. Doing so may cause accidental fire, electric shock or damage the LCD monitor.

# PRECAUTIONS

## Cautions When Using



Use only the power cord supplied with the LCD monitor.



The power outlet should be installed near the LCD monitor and be easily accessible.



If an extension cord is used with the LCD monitor, ensure that the total current consumption plugged into the power outlet does not exceed the ampere rating.



Do not allow anything to rest on the power cord. Do not place the LCD monitor where the power cord may be stepped on.



If the LCD monitor will not be used for an indefinite period of time, unplug the power cord from the power outlet.



To disconnect the power cord, grasp and pull by the plug head. Do not tug on the cord; doing so may cause fire or electric shock.



Do not unplug or touch the power cord with wet hands.



### WARNING:

Unplug the power cord from the power outlet and refer to qualified service personnel under the following conditions:



- When the power cord is damaged.
- If the LCD monitor has been dropped or the housing has been damaged.
- If the LCD monitor emits smoke or a distinct odor.



Ceiling mount or mount on any other horizontal surface overhead are not advisable.



### WARNING:

Installation in contravention of the instructions may result in undesirable consequences, particularly hurting people and damaging property. Users who have already mounted the monitor on the ceiling or any other horizontal surface overhead are strongly advised to contact AG Neovo for consultations and solutions to help ensure a most pleasurable and fulfilling monitor experience.

# PRECAUTIONS

---

## Cleaning and Maintenance

---



Do not attempt to service the LCD monitor yourself, refer to qualified service personnel.

Opening or removing the covers may expose you to dangerous voltage or other risks.

---

---

## Notice for the LCD Monitor

---

In order to maintain the stable luminous performance, it is recommended to use low brightness setting.

Due to the lifespan of the lamp, it is normal that the brightness quality of the LCD monitor may decrease with time.

When static images are displayed for long periods of time, the image may cause an imprint on the LCD monitor. This is called image retention or burn-in.

To prevent image retention, do any of the following:

- Set the LCD monitor to turn off after a few minutes of being idle.
- Use a screen saver that has moving graphics or a blank white image.
- Switch desktop backgrounds regularly.
- Adjust the LCD monitor to low brightness settings.
- Turn off the LCD monitor when the system is not in use.

Things to do when the LCD monitor shows image retention:

- Turn off the LCD monitor for extended periods of time. It can be several hours or several days.
  - Use a screen saver and run it for extended periods of time.
  - Use a black and white image and run it for extended periods of time.
- 

There are millions of micro transistors inside the LCD monitor. It is normal for a few transistors to be damaged and to produce spots. This is acceptable and is not considered a failure.

---

# CHAPTER 1: PRODUCT DESCRIPTION

## 1.1 Package Contents

When unpacking, check if the following items are included in the package. If any of them is missing or damaged, contact your dealer.

**LCD Monitor**



**Base**

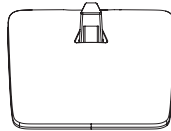

**Stand**



**Quick Start Guide**



**HDMI Cable**

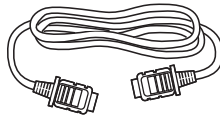

**Power Cord**

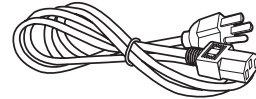

**Note:**

- Use only the supplied power cord.
- The above pictures are for reference only. Actual items may vary upon shipment.

# PRODUCT DESCRIPTION

## 1.2 Installation

### 1.2.1 Installing the Stand

1. Pinch the latches on the base and then attach the base to the arm. Ensure the base latches are secured to the slots on the arm.
2. Place the LCD monitor with the screen side down on a cushioned surface.
3. Attach the stand to the monitor.

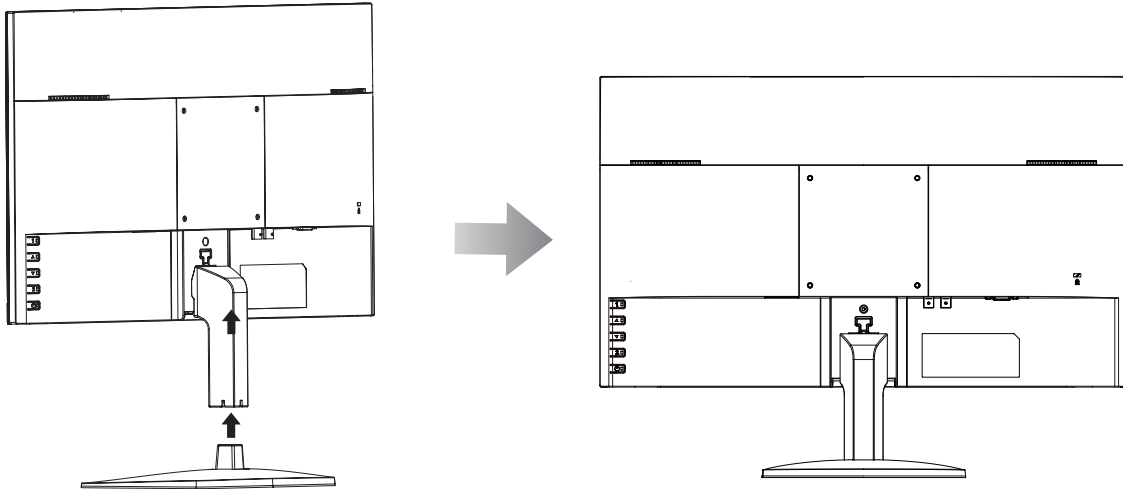

# PRODUCT DESCRIPTION

## 1.2.2 Adjusting the Tilt

For comfort viewing, tilt the LCD monitor up to an angle of  $-5^{\circ}$  to  $20^{\circ}$ . Hold the stand with one hand and use the other to adjust the LCD monitor to the desired angle.

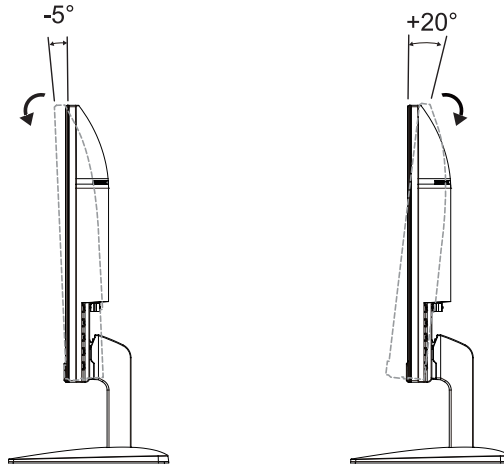

## 1.2.3 Wall Mounting

To wall mount the LCD monitor, do the following steps:

### 1. Remove the base stand.

Refer to page 35.

### 2. Wall mount the LCD monitor.

Screw the mounting bracket to the VESA holes at the rear of the LCD monitor.

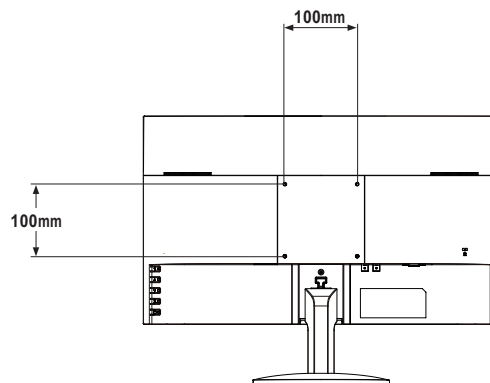

**Note:** Take measures to prevent the LCD monitor from falling down and lessen possible injury and damage to the monitor in case of earthquakes or other disasters.

- Use only the 100 x 100 mm wall mount kit recommended by AG Neovo. All AG Neovo wall mount kits comply with VESA standard.
- Secure the LCD monitor on a solid wall strong enough to bear its weight.
- It is suggested to wall mount the LCD monitor without tilting it facing downward.

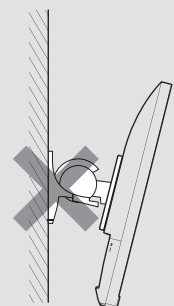

# PRODUCT DESCRIPTION

## 1.3 Overview

### 1.3.1 Front View

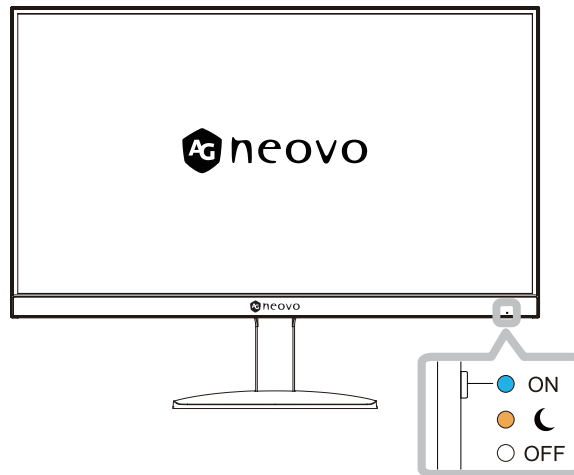

**Power status indicator:** Indicates the operating status of the monitor:

- Blue – Power On mode.
- Amber – Standby mode.
- LED off – Off mode.

# PRODUCT DESCRIPTION

## 1.3.2 Control Panel

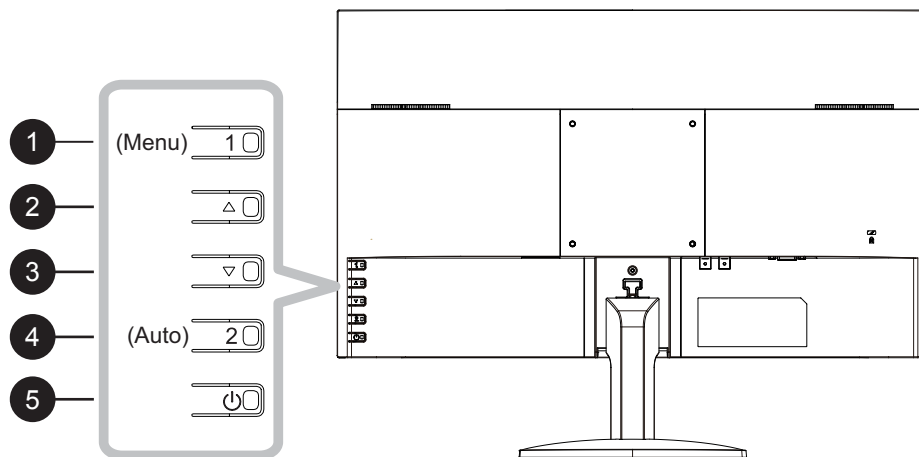

- 1 MENU  
OSD menu ON/OFF.
- 2 Hot Key: Source Key
  - When OSD menu is ON, navigate through adjustment icons or adjust a function.
- 3 When OSD menu is ON, navigate through adjustment icons or adjust a function.
- 4 Hot Key: Auto adjust for VGA
  - When OSD menu is ON, the key is used for function adjust confirm.Hot Key: Freeze On/Off (w/o VGA)
  - Press the AUTO button on the LCD display control panel to activate screen freeze, the screen freeze message is displayed on the screen.
- 5 POWER:  
Press to turn the monitor on or off.

# PRODUCT DESCRIPTION

## 1.3.3 Rear View

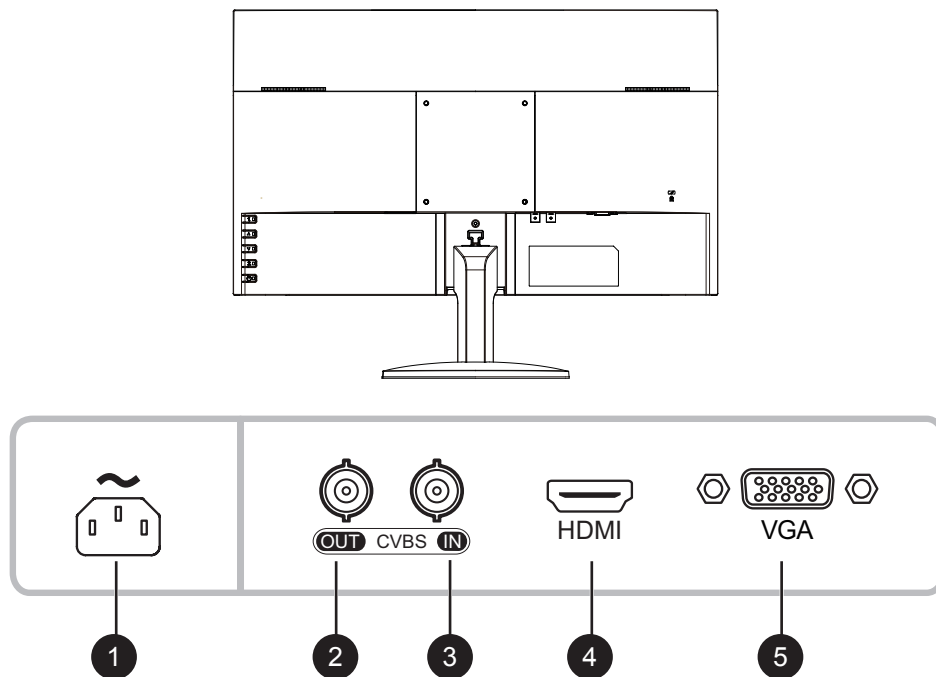

- 1 **~:**  
AC power input.
- 2 **COMPOSITE (CVBS) OUT:**  
Connect Composite (CVBS) signals output.
- 3 **COMPOSITE (CVBS) IN:**  
Connect Composite (CVBS) signals input.
- 4 **HDMI IN:**  
Connect HDMI signals input.
- 5 **VGA IN:**  
Connect VGA signals input.

# CHAPTER 2: MAKING CONNECTIONS



**CAUTION:**

Make sure that the LCD monitor is not connected to the power outlet before making any connections. Connecting cables while the power is ON may cause possible electric shock or personal injury.

## 2.1 Connecting the AC Power

1. Connect the power cord to the AC power input at the rear of the LCD monitor.
2. Connect the power cord plug to a power outlet or a power supply.

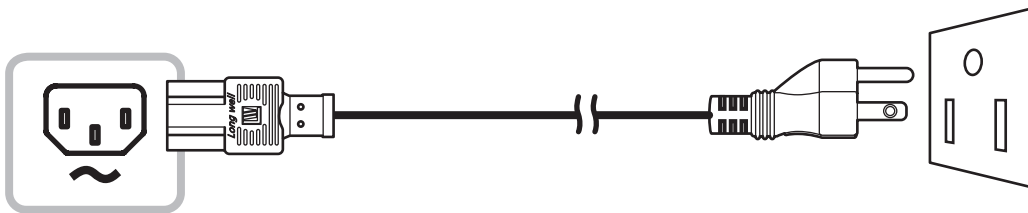

**CAUTION:**

When unplugging the power cord, hold the power cord by the plug head. Never pull by the cord.

# MAKING CONNECTIONS

## 2.2 Connecting Input Source Signals

Input source signals can be connected with either of the following cables:

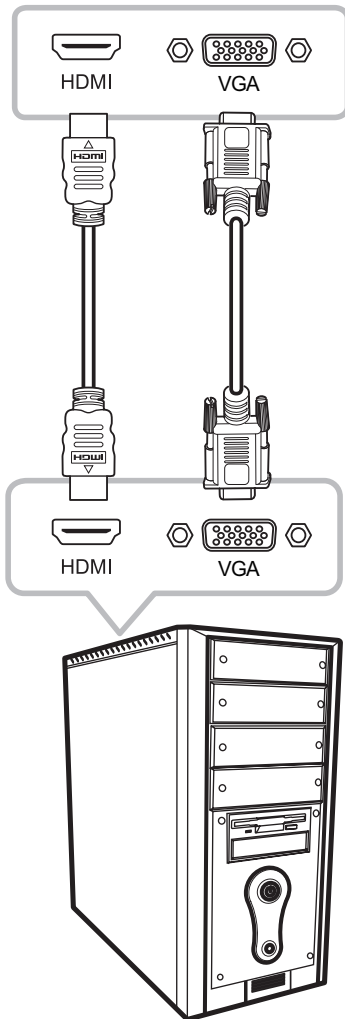

- **HDMI**

Connect one end of an HDMI cable to the HDMI connector of the LCD monitor and the other end to the HDMI connector of the computer.

- **VGA**

Connect one end of a D-Sub (VGA) cable to the D-Sub (VGA) connector of the LCD monitor and the other end to the D-Sub (VGA) connector of the computer.

# MAKING CONNECTIONS

## 2.3 Connecting a Video Device

- **CVBS OUT**

Connect one end of a composite cable to the CVBS OUT connector of the LCD monitor and the other end to the CVBS IN connector of the external display.

- **CVBS IN**

Connect one end of a composite cable to the CVBS IN connector of the LCD monitor and the other end to the CVBS OUT port of the video device.

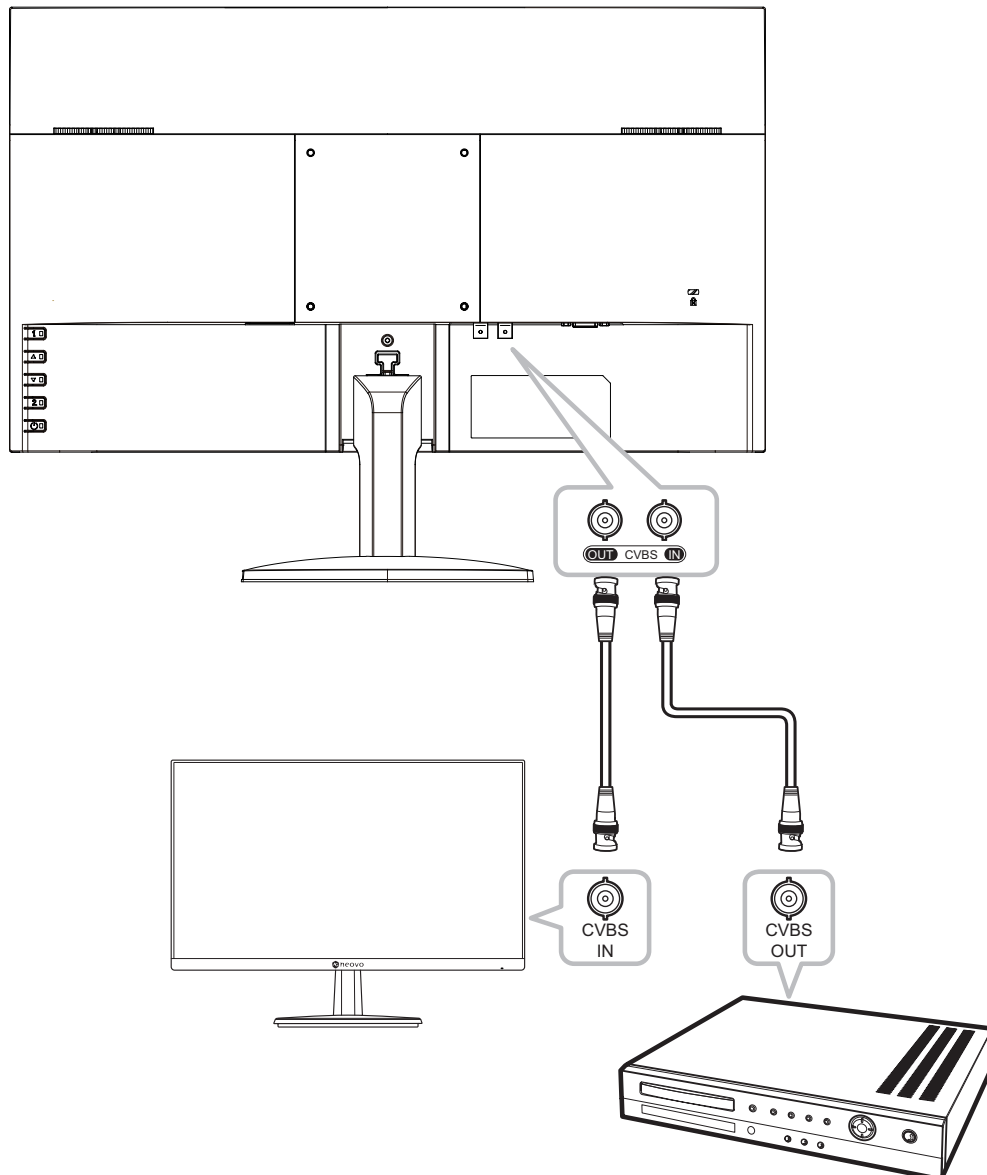

# CHAPTER 3: USING THE LCD MONITOR

## 3.1 Turning on the Power

1. Plug the power cord to a power outlet or power supply.
2. Press the  key on the control panel

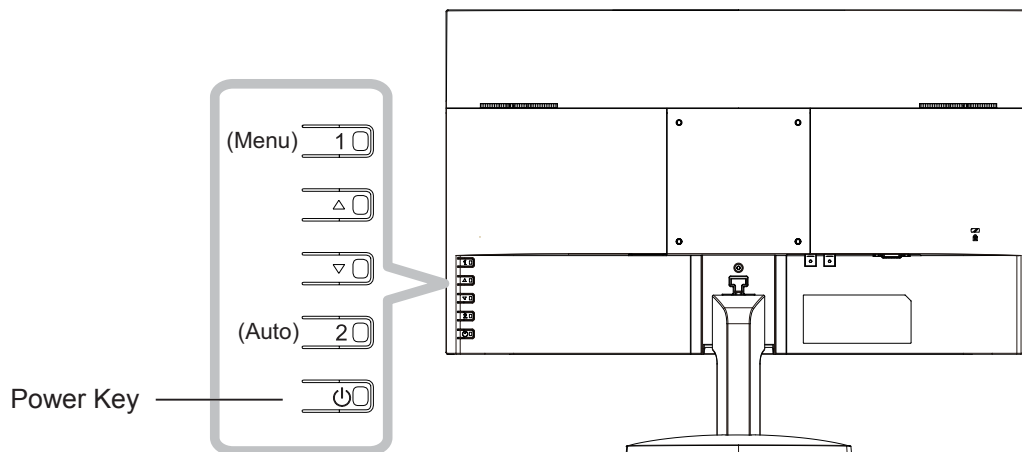

When the LCD monitor is turned on, press the  key to turn off the LCD monitor.

**Note:** The LCD monitor still consumes power as long as the power cord is connected to the power outlet.  
Disconnect the power cord to completely cut off power.

# USING THE LCD MONITOR

## 3.2 Displaying the OSD Menu

Press the 1(MENU) key to open the OSD menu. Press the 1(MENU) key again to close the OSD menu.

For more information on adjusting settings, refer to page 22.

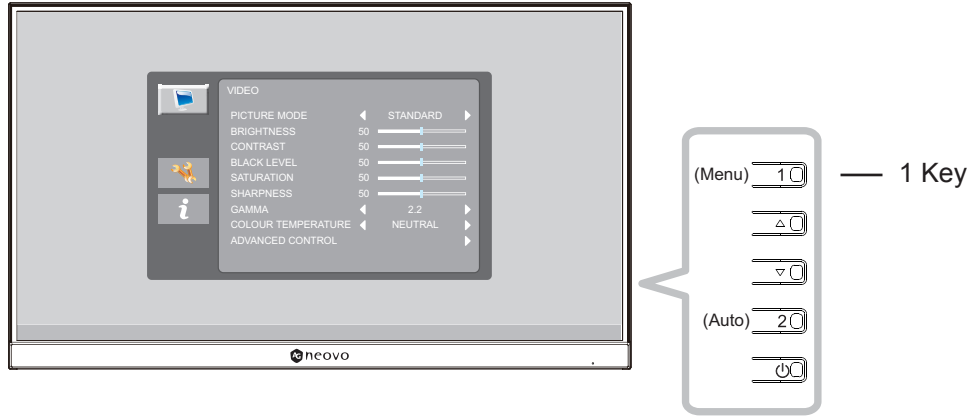

The following menu appears on the screen:

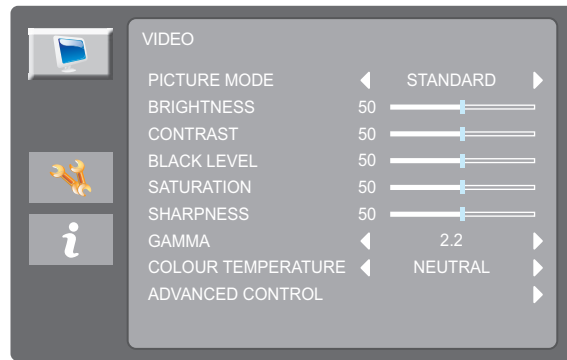

# USING THE LCD MONITOR

## 3.3 Selecting a Source

Press the ▲ key to call out the source selection menu.

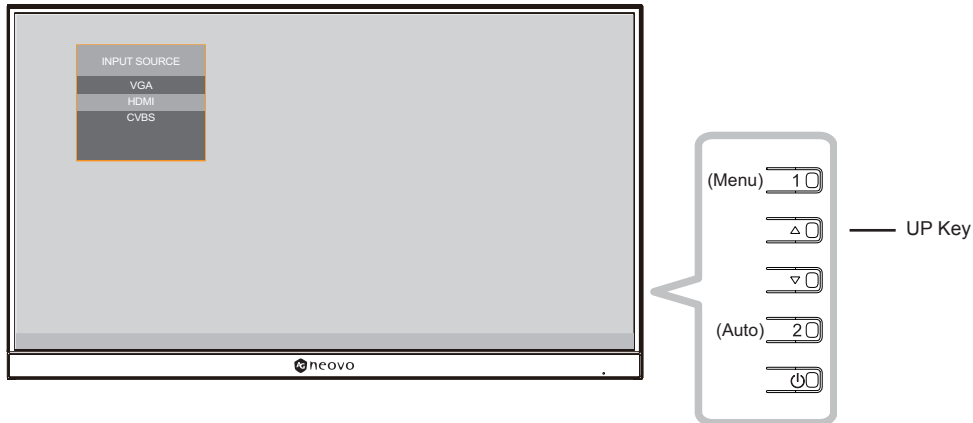

The following menu appears on the screen:

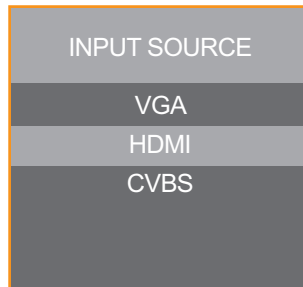

Press the ▲ key continuously to select the desired input source. Then press the 2 (AUTO) key to confirm or wait until the source menu disappears from the screen automatically. The available input options include “CVBS”, “HDMI”, and “VGA”.

**Note:** Every time you switch to the VGA source, the LCD monitor performs screen adjustment automatically.

# USING THE LCD MONITOR

## 3.4 Auto Adjusting the Screen (For VGA Source Only)

Auto Adjustment function automatically tunes the LCD monitor to its optimal setting, including horizontal position, vertical position, clock, and phase.

Press the 2(AUTO) key to perform auto adjustment for VGA source.

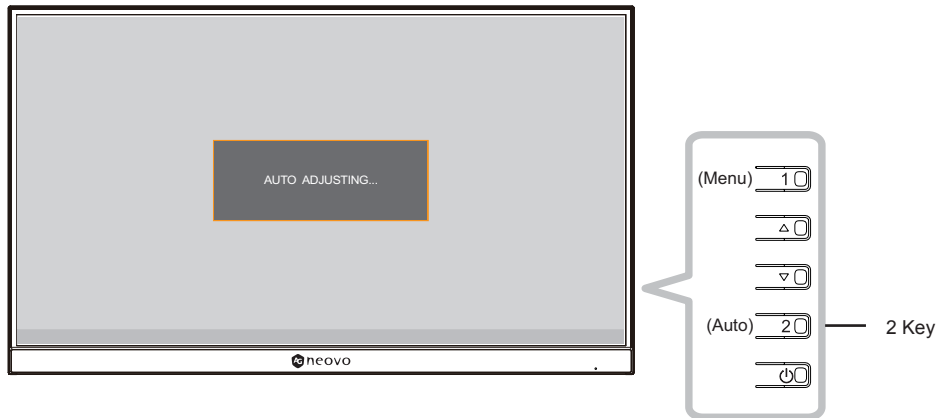

The following message appears on the screen:



During the auto adjustment, the screen will slightly shake for a few seconds.

The screen adjustment is complete when the AUTO ADJUSTING message disappears from the screen.

**Note:** *It is recommended to use the auto adjustment function when using the LCD monitor for the first time or after a resolution change.*

# USING THE LCD MONITOR

## 3.5 Locking the Control Keys

Locking the control keys helps to prevent unwanted access to the LCD monitor settings.

Press the 1(MENU) key for 5 seconds to lock all keys except for Power.

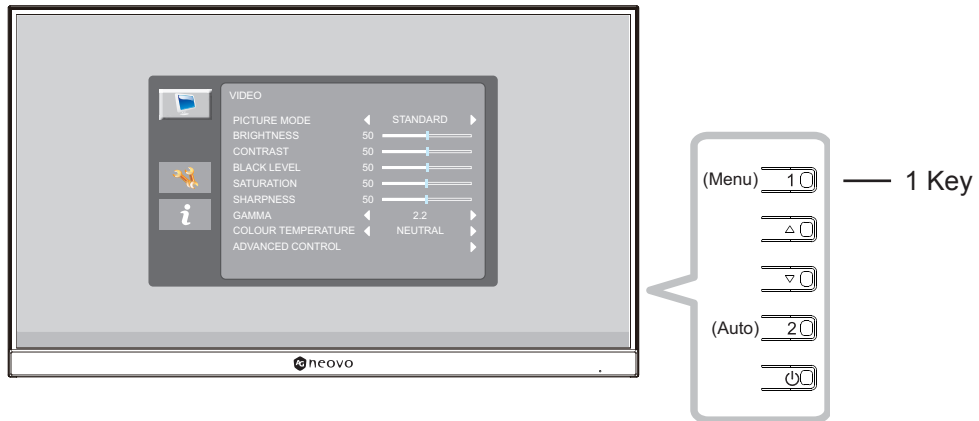

The keypad lock message is displayed on the screen.

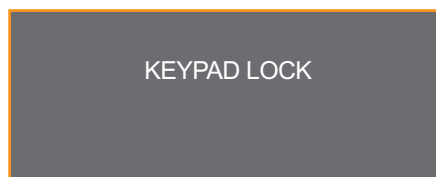

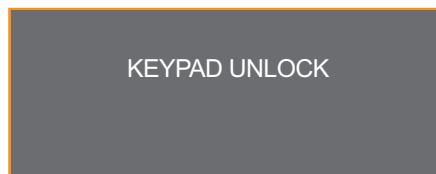

To unlock the control keys, press the 1(MENU) key again for 5 seconds.

The keypad unlock message is displayed on the screen.

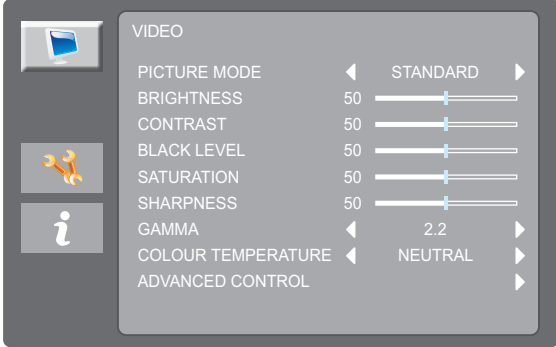
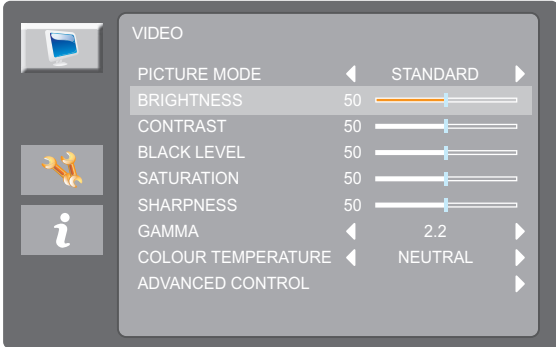

# CHAPTER 4: ON SCREEN DISPLAY MENU

## 4.1 Using the OSD Menu

#	Menu Navigation	Operation
1	<p>Display the main menu screen.</p> 	<p>Press 1(MENU) on the control panel.</p>
2	<p>Enter the submenu.</p>  <p>The highlighted item (light grey bar) indicates the active submenu item.</p>	<ol style="list-style-type: none"> <li>1 Press ▲ / ▼ to select the menu item.</li> <li>2 Press 2(AUTO) to enter submenu.</li> <li>3 Press ▲ / ▼ to select the submenu item.</li> <li>4 Press 2(AUTO) to enter adjustment mode.</li> </ol>
3	<p>Adjust the settings.</p> <p>For example:</p> 	<p>Press 2(AUTO) (repeatedly) to change the setting or press ▲ / ▼ to adjust the value.</p>
4	<p>Return to the previous menu and/or close the OSD window.</p>	<p>Press 1(MENU) once to return to the previous menu. Press 1(MENU) repeatedly to close the OSD window.</p>

**Note:** When settings are modified, all changes are saved when the user does the following:

- Proceeds to another menu
- Exits the OSD menu
- Waits for the OSD menu to disappear

# ON SCREEN DISPLAY MENU

## 4.2 OSD Menu Tree

Main Menu	Submenu	Reference
VIDEO	PICTURE MODE	Refer to page 24.
	BRIGHTNESS	
	CONTRAST	
	BLACK LEVEL	
	SATURATION	
	TINT	
	SHARPNESS	
	GAMMA	
	COLOUR TEMPERATURE	
	ADVANCED CONTROL	
	AUTO ADJUST	
	AUTO COLOUR	
SETTING	LANGUAGE	Refer to page 28.
	BACKLIGHT	
	OSD TIMER	
	OSD TRANSPARENCY	
	STANDBY	
	VPM	
	SOURCE DETECT	
	BLUE SCREEN	
	COLOUR SYSTEM	
	ANTI-BURN-IN	
	RESET DEFAULT	
INFORMATION	INPUT:	Refer to page 31.
	RESOLUTION:	
	HORIZONTAL FREQ.:	
	VERTICAL FREQ.:	
	TIMING MODE:	
	F/W VERSION:	

**Note:** Availability of some menu items depend on the input source signal. If the menu is not available, it is not visible or disabled and greyed out.



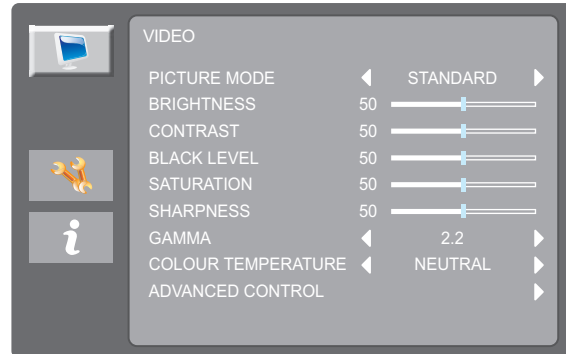

# CHAPTER 5: ADJUSTING THE LCD MONITOR

## 5.1 VIDEO Menu

1. Press 1(MENU) on the control panel to call out the OSD window.
2. Press ▲ / ▼ to select  and then press 2(AUTO) to enter the VIDEO menu.

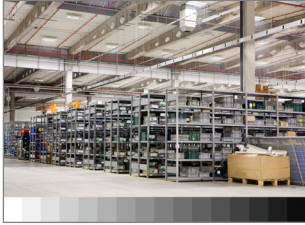

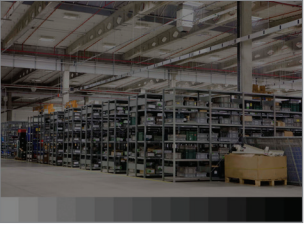
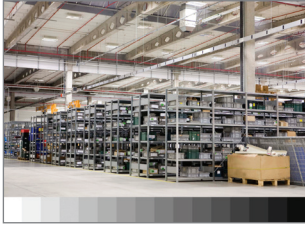
3. Press ▲ / ▼ to select an option and press 2 or AUTO to enter its submenu.

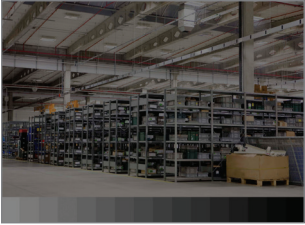
Item	Function	Operation	Range
PICTURE MODE	Selects a predefined picture mode setting. <b>Note:</b> The recommended PICTURE MODE for optimised PC source is STANDARD and ASPECT RATIO is 16:9. In optimised mode, SATURATION and SHARPNESS parameters cannot be modified.	Press 2(AUTO) (repeatedly) to select the setting.	STANDARD CCTV VIDEO
BRIGHTNESS	Adjusts the luminance of the screen image.	Press ▲ / ▼ to adjust the value.	0 to 100
<div style="display: flex; justify-content: space-around;"> <div style="text-align: center;"> <p><i>Original Setting</i></p>  </div> <div style="text-align: center;"> <p><i>High Setting</i></p>  </div> <div style="text-align: center;"> <p><i>Low Setting</i></p>  </div> </div>			
CONTRAST	Adjusts the difference between the black level and the white level.	1 Press 2(AUTO). 2 Press ▲ / ▼ to adjust the value.	0 to 100
<div style="display: flex; justify-content: space-around;"> <div style="text-align: center;"> <p><i>Original Setting</i></p>  </div> <div style="text-align: center;"> <p><i>High Setting</i></p>  </div> <div style="text-align: center;"> <p><i>Low Setting</i></p>  </div> </div>			
BLACK LEVEL	Adjusts the black level of the screen image. Low brightness setting makes black colour darker.	Press ▲ / ▼ to adjust the value.	0 to 100

# ADJUSTING THE LCD MONITOR

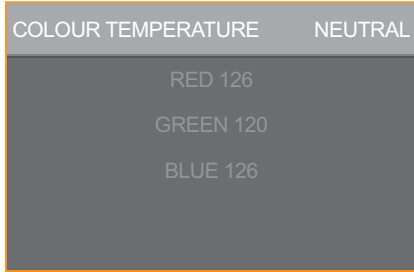
Item	Function	Operation	Range
SATURATION	Adjusts the colour saturation. <b>Note:</b> This menu item is only available for HDMI and CVBS sources.	Press ▲ / ▼ to adjust the value.	0 to 100
TINT	Adjusts the colour tint. <b>Note:</b> This menu item is only available for CVBS source.		0 to 100
SHARPNESS	Adjusts the clarity and focus of the screen image. <b>Note:</b> This menu item is only available for HDMI and CVBS (NTSC) sources.		0 to 100
GAMMA	Adjusts the non-linear setting for picture luminance and contrast.	Press 2(AUTO) (repeatedly) to select the setting.	1.8 2.0 2.2 2.4 S
COLOUR TEMPERATURE	Provides several colour adjustment settings. 		NEUTRAL WARM COOL USER
<p>Colour temperature can be set to:</p> <ul style="list-style-type: none"> <li>• “NEUTRAL” - This is the default colour temperature commonly used for normal lighting conditions.</li> <li>• “WARM” - Applies a reddish tint for warmer colours.</li> <li>• “COOL” - Applies a bluish tint for cooler colours.</li> <li>• “USER” - This allows users to set the colour temperature by adjusting the red, green, or blue setting according to one’s preference.               <ol style="list-style-type: none"> <li>a. Select “USER” and press ▼.</li> <li>b. Press 2 (AUTO) to enter “RED” settings.</li> <li>c. Press ▲ / ▼ to adjust the value (0 to 255).</li> <li>d. When done, press 1 or MENU to return to the previous menu. To adjust green and blue, press ▲ / ▼ tand repeat steps b to c.</li> </ol> </li> </ul>			

# ADJUSTING THE LCD MONITOR

Item	Function	Operation	Range
ADVANCED CONTROL	Configures advanced control settings.	Press 2(AUTO).	-
	<ul style="list-style-type: none"> <li>• “NOISE REDUCTION” - Reduces the noise in the picture due to poor reception or poor picture quality.</li> </ul>	<ol style="list-style-type: none"> <li>1 Press ▲ / ▼.</li> <li>2 Press 2(AUTO) (repeatedly) to select the setting.</li> </ol>	OFF LOW MIDDLE HIGH
	<ul style="list-style-type: none"> <li>• “COLOR RANGE” - Adjusts black and white levels for video. <b>Note:</b> This menu item is only available for HDMI source at PICTURE mode (CVBS / VIDEO)</li> </ul>		FULL LIMIT
	<ul style="list-style-type: none"> <li>• “DCR (Dynamic Contrast Ratio)” - Automatically adjusts the backlight range according to the display screen, such as when watching movies. DCR is suitable for indoor viewing. <b>Note:</b> This menu item is only available for HDMI source.</li> </ul>		OFF ON
	<ul style="list-style-type: none"> <li>• “CONTRAST ENHANCER” - Automatically adjusts picture brightness and contrast at high speed and dynamic contrast range, such as when watching movies. <b>Note:</b> This menu item is only available for HDMI source at PICTURE mode (CVBS / VIDEO)</li> </ul>		OFF ON
<ul style="list-style-type: none"> <li>• “ASPECT RATIO” - Adjusts the aspect ratio of the screen image. <b>Note:</b> The ZOOM1 and ZOOM2 options are only available if the input source is CVBS.</li> </ul>	16:9 NATIVE 4:3 ZOOM1 ZOOM2		
AUTO ADJUST	Configures auto adjustment settings. <b>Note:</b> This menu item is only available for VGA source.	Press 2(AUTO).	-
	<ul style="list-style-type: none"> <li>• “AUTO ADJUST” - Automatically tunes the LCD monitor to its optimal setting, including horizontal position, vertical position, clock, and phase.</li> </ul> 	<ol style="list-style-type: none"> <li>1 Press ▲ / ▼.</li> <li>2 Press 2(AUTO).</li> </ol>	-

# ADJUSTING THE LCD MONITOR

Item	Function	Operation	Range
AUTO ADJUST	<ul style="list-style-type: none"> <li>• “H.POSITION (Horizontal Position)” - Moves the screen image to the left or right.</li> </ul>	<ol style="list-style-type: none"> <li>1 Press ▲ / ▼.</li> <li>2 Press 2(AUTO).</li> <li>3 Press ▲ / ▼ to adjust the value.</li> </ol>	0 to 100
	<ul style="list-style-type: none"> <li>• “V.POSITION (Vertical Position)” - Moves the screen image up or down.</li> </ul>		0 to 100
	<ul style="list-style-type: none"> <li>• “PHASE” - Adjusts the phase timing to synchronise with the video signal.</li> </ul>		0 to 100
	<ul style="list-style-type: none"> <li>• “CLOCK” - Adjusts the frequency timing to synchronise with the video signal.</li> </ul>		0 to 100
AUTO COLOUR	<p>Operates the white balance and automatically adjusts the colour settings.</p>  <p><b>Note:</b> This menu item is only available for VGA source.</p>	Press 2(AUTO).	-

# ADJUSTING THE LCD MONITOR

## 5.2 SETTING Menu

1. Press 1(MENU) on the control panel to call out the OSD window.
2. Press ▲ / ▼ to select  and then press 2(AUTO) to enter the SETTING menu.

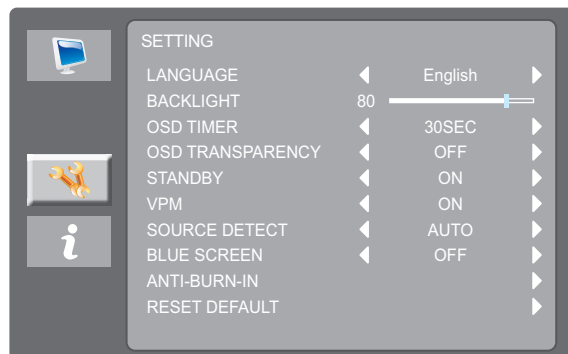

3. Press ▲ / ▼ to select an option and press 2(AUTO) to enter its submenu.

Item	Function	Operation	Range
LANGUAGE	Choose the language used for OSD menus.	Press 2(AUTO) (repeatedly) to select the setting.	English Español Français Deutsch 简体中文 繁體中文
BACKLIGHT	Adjusts the luminance of the screen image.	Press ▲ / ▼ to adjust the value.	0 to 100
OSD TIMER	Sets the length of time (in seconds) the OSD screen is displayed. When the time elapses, the OSD screen is automatically inactivated.	Press 2(AUTO) (repeatedly) to select the setting.	OFF 10SEC 20SEC 30SEC 40SEC 50SEC 60SEC
OSD TRANSPARENCY	Adjusts the OSD transparency.		OFF LOW MIDDLE HIGH

# ADJUSTING THE LCD MONITOR

Item	Function	Operation	Range
STANDBY	Enables or disables standby mode.  <b>Note:</b> The amount of time for the display to enter standby varies depending on the "SOURCE DETECT" setting. If the "SOURCE DETECT" is set to "AUTO", the display checks all input source signals before entering standby mode if no signal is detected; this takes up more time. If the "SOURCE DETECT" is set to "MANUAL", the display enters standby mode right away.	Press 2(AUTO) (repeatedly) to select the setting.	OFF ON
VPM	Enables the VPM feature to wake up the monitor from standby mode. And this menu option is only available if the input source is CVBS.  <b>Note:</b> Please turn on the VPM option before the CVBS input source is connected.		OFF ON
SOURCE DETECT	Sets the display to automatically or manually detect the input source signal.		AUTO MANUAL
BLUE SCREEN	If no input signal is available, the background of the screen is blue.		OFF ON
COLOUR SYSTEM	Select the input signal system.  <b>Note:</b> This menu item is only available for CVBS source.		AUTO PAL PAL_60 NTSC NTSC_443 SECAM

# ADJUSTING THE LCD MONITOR

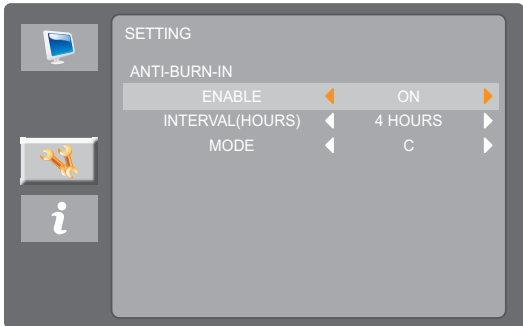
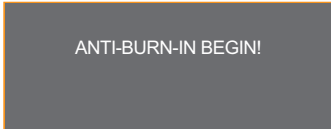
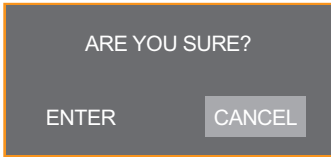
Item	Function	Operation	Range
ANTI-BURN-IN	<p>Protects the display from “burn-in” or “afterimage” symptoms when the display has not being used for a period of time.</p>  <p><b>Note:</b> When Anti-Burn-in™ starts, you will see the following notification:</p> 	<ol style="list-style-type: none"> <li>1 Press ▲ / ▼.</li> <li>2 Press 2(AUTO) to enter the submenu.</li> </ol>	-
ANTI-BURN-IN	<ul style="list-style-type: none"> <li>• “ENABLE” - Enables or disables Anti-Burn-in™ function.</li> <li>• “INTERVAL(HOURS)” - Selects the interval time (hour) between activating the Anti-Burn-in™ function.</li> <li>• “MODE” - Sets the Anti-Burn-in™ mode to “A” (execute fast), “B” (slower but more precise than mode “A”), or C (slowest but the most precise mode).</li> </ul>	Press 2(AUTO) (repeatedly) to select the setting.	<p>OFF ON</p> <p>4 HOURS 5 HOURS 6 HOURS 8 HOURS</p> <p>A B C</p>
RESET DEFAULT	<p>Resets all settings to the factory defaults.</p> 	<ol style="list-style-type: none"> <li>1 Press ▲ / ▼.</li> <li>2 Press 2(AUTO) to confirm.</li> </ol>	ENTER CANCEL

# ADJUSTING THE LCD MONITOR

## 5.4 INFO Menu

1. Press 1(MENU) on the control panel to call out the OSD window.
2. Press ▲ / ▼ to select  and then press 2(AUTO) to enter the INFORMATION menu.

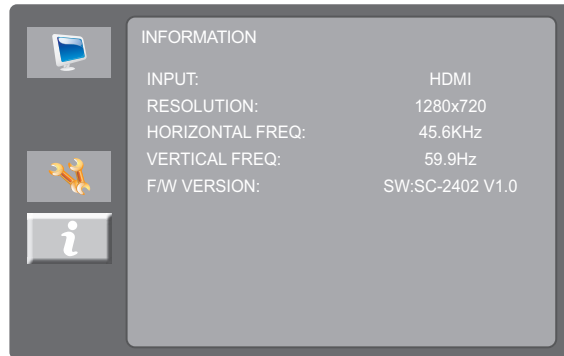



3. Review LCD monitor information.

# CHAPTER 6: APPENDIX

## 6.1 Warning Messages

When any of these warning messages appear, check the following items.

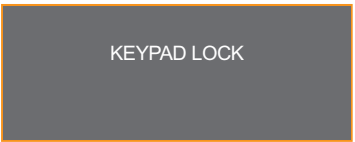
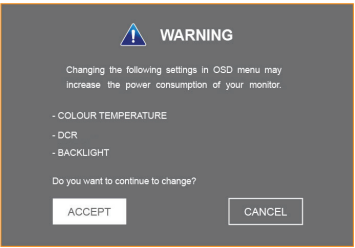
Warning Message	Cause	Solution
	The resolution or the refresh rate of the graphics card of the computer is set too high.	<ul style="list-style-type: none"> <li>√ Change the resolution or the refresh rate of the graphics card.</li> </ul>
	The LCD monitor cannot detect the input source signal.	<ul style="list-style-type: none"> <li>√ Check if the input source is turned ON.</li> <li>√ Check if the signal cable is properly connected.</li> <li>√ Check if any pin inside the cable connector is twisted or broken.</li> </ul>
	Keypad has been locked.	<ul style="list-style-type: none"> <li>√ Press the 1 key or MENU for 5 seconds to enable/disable the KEY LOCK (w/o POWER) function.</li> </ul>
	This warning message box will only show when the menu feature setting is changed for the first time.	<ul style="list-style-type: none"> <li>√ Select ACCEPT to continue the setting changes, or select CANCEL to disable the setting changes.</li> </ul> <div style="border: 1px solid gray; padding: 5px; margin-top: 10px;"> <p><b>Note:</b> <i>The operation may vary from different product models.</i></p> </div>



# CHAPTER 6: APPENDIX

## 6.2 Timing

PC MODE	VIDEO
720 x 400p at 70 Hz	720 x 480i at 60 Hz
640 x 480p at 60 Hz	720 x 480 at 60 Hz
640 x 480p at 72 Hz	720 x 576i at 50 Hz
640 x 480p at 75 Hz	720 x 576 at 50 Hz
800 x 600p at 56 Hz	1280 x 720 at 50 Hz
800 x 600p at 60 Hz	1280 x 720 at 60 Hz
800 x 600p at 72 Hz	1920 x 1080i at 50 Hz
800 x 600p at 75 Hz	1920 x 1080 at 50 Hz
1024 x 768p at 60 Hz	1920 x 1080i at 60 Hz
1024 x 768p at 70 Hz	1920 x 1080 at 60 Hz
1024 x 768p at 75 Hz	1920 x 1080 at 24 Hz
1280 x 1024p at 60 Hz	1920 x 1080 at 25 Hz
1366 x 768p at 60 Hz	1920 x 1080 at 30 Hz
1600 x 900p at 60 Hz	
1440 x 900p at 60 Hz	
1280 x 720p at 60 Hz	
1152 x 864p at 75 Hz	
1920 x 1080p at 60 Hz	

# APPENDIX

## 6.3 Troubleshooting

Problems	Possible Cause and Solution
No picture. <ul style="list-style-type: none"><li>• LED indicator is OFF.</li></ul>	<ul style="list-style-type: none"><li>• Check if the LCD monitor is turned ON.</li><li>• Check if the power cord is properly connected to the LCD monitor.</li><li>• Check if the power cord is plugged into the power outlet.</li></ul>
<ul style="list-style-type: none"><li>• LED indicator is green.</li></ul>	<ul style="list-style-type: none"><li>• Check if the computer is turned ON.</li><li>• Check if the computer is in standby mode, move the mouse or press any button to wake up the computer.</li></ul>
Image position is incorrect.	<ul style="list-style-type: none"><li>• For VGA input, press 2 or AUTO on the control panel to auto adjust the screen.</li><li>• For VGA input, adjust the “H. POSITION” and “V. POSITION” settings in “VIDEO (  ) &gt; AUTO ADJUST” menu (refer to page 27).</li></ul>
The displayed texts are blurry.	<ul style="list-style-type: none"><li>• For VGA input, press 2 or AUTO on the control panel to auto adjust the screen.</li><li>• For VGA input, adjust the “CLOCK” and “PHASE” settings in “VIDEO (  ) &gt; AUTO ADJUST” menu (refer to page 27).</li></ul>
Red, blue, green, white dots appear on the screen.	<ul style="list-style-type: none"><li>• There are millions of micro transistors inside the LCD monitor. It is normal for a few transistors to be damaged and to produce spots. This is acceptable and is not considered a failure.</li></ul>
Dew formed on the LCD monitor.	<ul style="list-style-type: none"><li>• This normally happens when the LCD monitor is moved from a cold room to a hot room temperature. Do not turn ON the LCD monitor, wait for the dew condensation to disappear.</li></ul>
Faint shadows from a static image appear on the screen.	<ul style="list-style-type: none"><li>• Turn off the LCD monitor for extended periods of time.</li><li>• Use a screen saver or a black and white image and run it for extended periods of time.</li></ul>

# APPENDIX

## 6.4 Transporting the LCD Monitor

To transport the LCD monitor for repair or shipment, place the monitor in its original packaging box.

### 1. Remove the base stand.

Press on the release latch and detach the base stand from the LCD monitor.

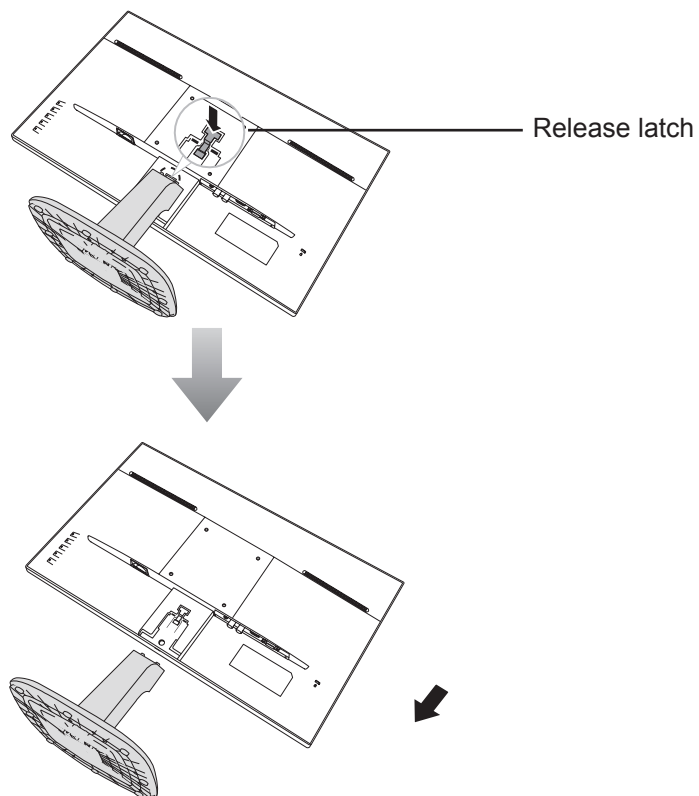

### 2. Remove the base.

Pinch the latches on the base and detach the arm from the base.

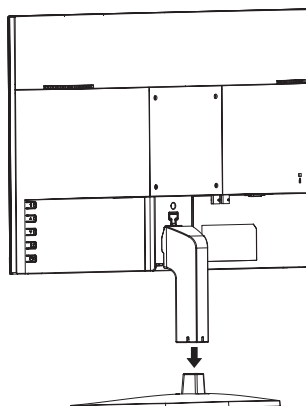

# APPENDIX

3. Place the lower foam cushion inside the box.
4. Place the LCD monitor down in the box.
5. Place the upper foam cushion on the top of the LCD monitor.
6. Place the accessories on the designated area (if necessary).
7. Close and tape the box.

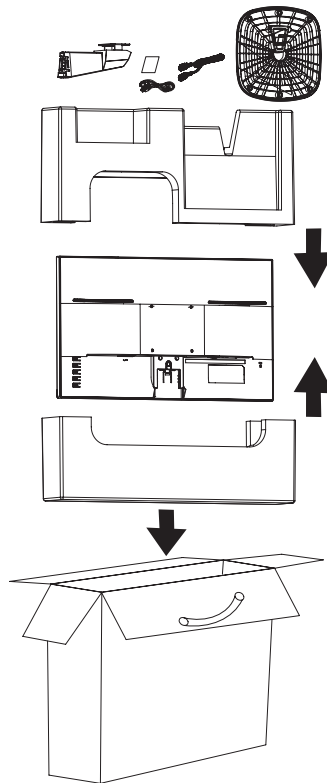

**Note:** *It is recommended to use the original packaging box.*

# CHAPTER 7: SPECIFICATIONS

## 7.1 Display Specifications

		SC-2203
Panel	Panel Type	LED-Backlit TFT LCD (VA Technology)
	Panel Size	21.45"
	Max. Resolution	FHD 1920 x 1080
	Pixel Pitch	0.241 mm
	Brightness	280 cd/m <sup>2</sup>
	Contrast Ratio	20,000,000:1 (DCR)
	Viewing Angle (H/V)	178°/178°
	Display Colour	16.7M
	Response Time	5 ms
	Surface Treatment	Haze 25%, Hard Coating (3H)
Frequency (H/V)	H Freq.	30 kHz-85 kHz
	V Freq.	48 Hz-75 Hz
Input	HDMI	1.4 x 1
	VGA	15-Pin D-Sub x 1
	Composite	BNC x 1
Output	Composite	BNC x 1
Power	Power Supply	Internal
	Power Requirements	AC 100-240V, 50/60 Hz
	On Mode	16W (On)
	Standby Mode	< 0.5W
	Off Mode	< 0.3W
Operating Conditions	Temperature	5°C-35°C (41°F-95°F)
	Humidity	20%-85% (non-condensing)
Storage Conditions	Temperature	-20°C-60°C (-4°F-140°F)
	Humidity	10%-90% (non-condensing)
Mounting	VESA FPMPI	Yes (100 x 100 mm)
Stand	Tilt	-5° to 20°
Security	Kensington Security Slot	Yes
Dimensions	Product with Base (W x H x D)	491.8 x 373.8 x 167.4 mm (19.4" x 14.7" x 6.6")
	Product w/o Base (W x H x D)	491.8 x 289.5 x 44.9 mm (19.4" x 11.4" x 1.8")
	Packaging (W x H x D)	555.0 x 373.0 x 110.0 mm (21.9" x 14.7" x 4.3")
Weight	Product with Base	2.6 kg (5.7 lb)
	Product w/o Base	2.3 kg (5.1 lb)
	Packaging	3.6 kg (7.9 lb)

**Note:** All specifications are subject to change without prior notice.

# SPECIFICATIONS

## 7.2 Display Dimensions

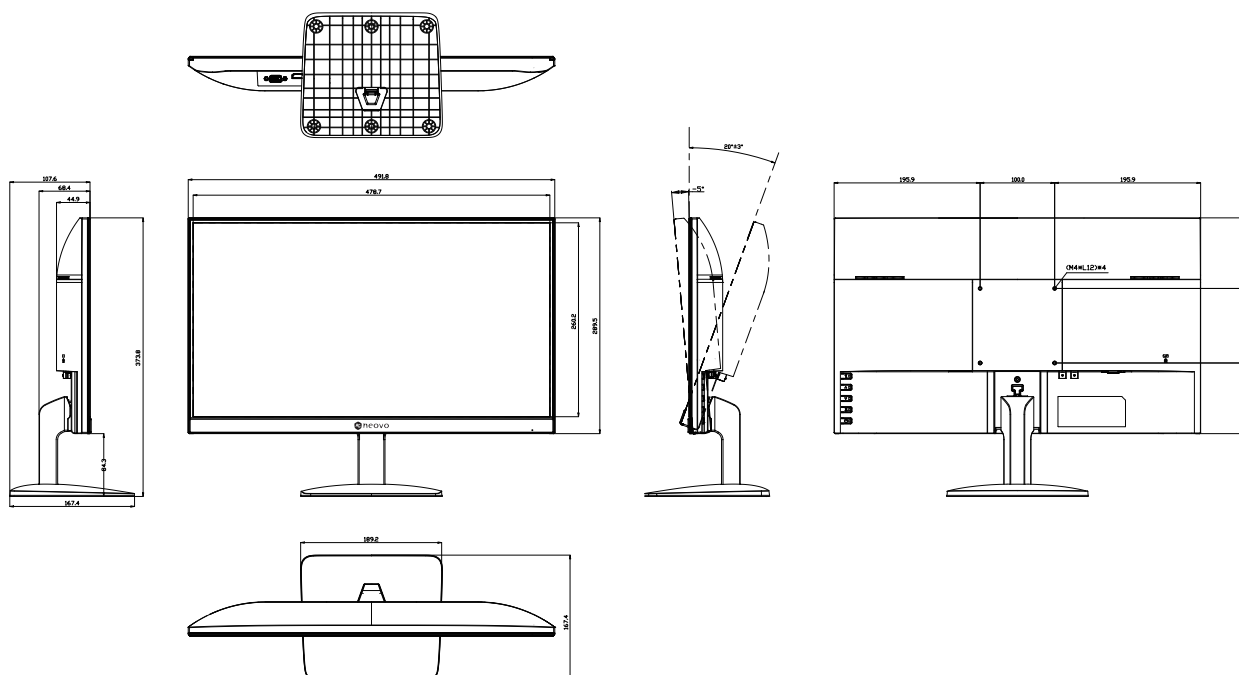

### AG Neovo

Company Address: 5F-1, No. 3-1, Park Street, Nangang District, Taipei, 11503, Taiwan.

Copyright © 2026 AG Neovo. All rights reserved.

SC-2203 Eprel registration number: 1949709

SC2230\_UM\_V011