

SC-19E

Net weight :2.3kg (with stand)  
2.0kg (w/o stand)

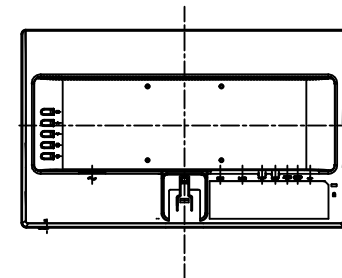
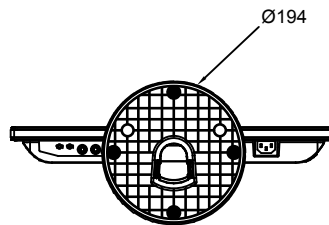
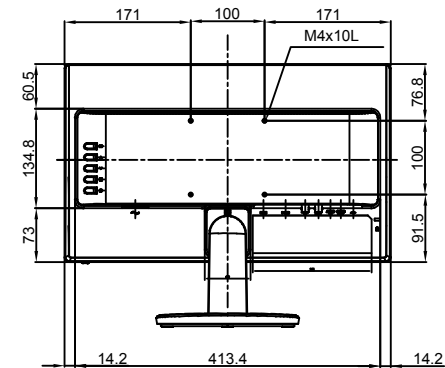
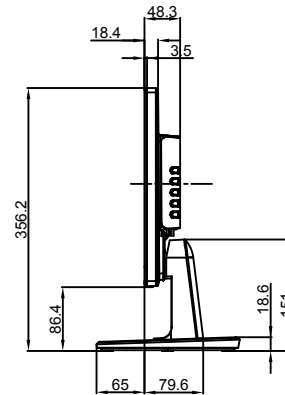
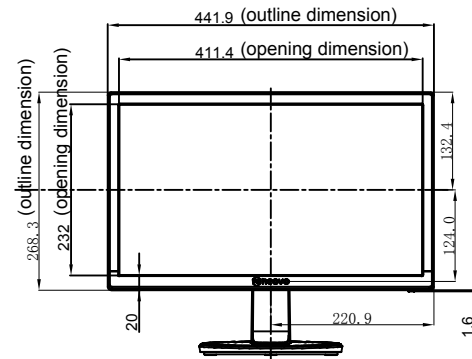
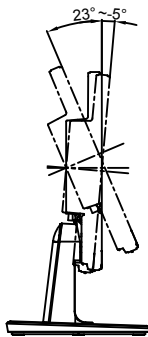
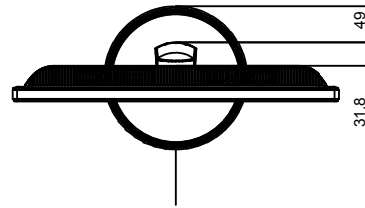

SPECIFICATIONS SUBJECT TO CHANGE WITHOUT NOTICE.

 www.agneovo.com	Model Name: <b>SC-19E</b>				
	P/C:S19E00				
<small>THIS DRAWING ON THIS PRINT AND INFORMATION BELONG WITH AG Neovo. ANY REPRODUCTION IN PART OR WHOLE WITHOUT WRITTEN PERMISSION OF AG Neovo IS PROHIBITED.</small>		<small>ORTHOGONAL PROJECTION</small>	SCALE 1:1	UNITS mm	V.1.02