



**THE DISPLAY CHOICE  
OF PROFESSIONALS™**

**TX-15, TX-17 & TX-19 Multi-touch Display**

[www.agneovo.com](http://www.agneovo.com)

# **User Manual**

The information contained in this document is subject to change without notice.

This document contains proprietary information that is protected by copyright. All rights are reserved. No part of this document may be reproduced, translated to another language or stored in a retrieval system, or transmitted by any means, electronic, mechanical, photocopying, recording, or otherwise, without prior written permission. Windows is a registered trademark of Microsoft, Inc. Other brand or product names are trademarks of their respective holders.

# TABLE OF CONTENTS

## SAFETY INFORMATION

Federal Communications Commission (FCC) Notice (U.S. Only).....	4
---	---

## Usage Notice

Precautions .....	5
-------------------	---

## Chapter 1: Product Description

1.1 Package Overview .....	6
----------------------------	---

## Chapter 2: Installation

2.1 Product Overview .....	7
2.1.1 Front View .....	7
2.1.2 Bottom View (Without Stand) .....	7
2.2 Kensington Security Slot .....	8
2.3 VESA Mount for Your Monitor.....	9
2.4 Start Your Installation .....	10
2.5 Connecting the Display .....	11
2.6 Remove the Deskstand .....	12

## Chapter 3: User Controls

3.1 Back Panel Controls.....	13
3.2 How to Use the OSD Menus .....	14
3.3 On-Screen Display Menus .....	15

## Chapter 4: Appendix

4.1 Troubleshooting.....	16
4.2 Warning Signal .....	17
4.2.1 No Signal.....	17
4.2.2 Going to Sleep.....	17
4.2.3 Out of Range .....	17
4.3 Product Dimensions .....	18
4.4 Compatibility Modes .....	21
4.5 Touch Screen Driver Installation.....	24
4.5.1 Optional Calibration Tool Install.....	24
4.5.2 Driver Install Instructions .....	26

## Chapter 5: Specifications

5.1 Display Specifications .....	27
----------------------------------	----

# SAFETY INFORMATION

## Federal Communications Commission (FCC) Notice (U.S. Only)

### TX-15



This equipment has been tested and found to comply with the limits for a Class B digital device, pursuant to part 15 of the FCC Rules. These limits are designed to provide reasonable protection against harmful interference in a residential installation. This equipment generates, uses and can radiate radio frequency energy and, if not installed and used in accordance with the instructions, may cause harmful interference to radio communications. However, there is no guarantee that interference will not occur in a particular installation. If this equipment does cause harmful interference to radio or television reception, which can be determined by turning the equipment off and on, the user is encouraged to try to correct the interference by one or more of the following measures:

- Reorient or relocate the receiving antenna.
- Increase the separation between the equipment and receiver.
- Connect the equipment into an outlet on a circuit different from that to which the receiver is connected.
- Consult the dealer or an experienced radio/TV technician for help.



Changes or modifications not expressly approved by the party responsible for compliance could void the user's authority to operate the equipment.

Use only an RF shielded cable that was supplied with the display when connecting this display to a computer device.

To prevent damage which may result in fire or shock hazard, do not expose this appliance to rain or excessive moisture.

THIS CLASS B DIGITAL APPARATUS MEETS ALL REQUIREMENTS OF THE CANADIAN INTERFERENCE-CAUSING EQUIPMENT REGULATIONS.



This device complies with Part 15 of the FCC Rules. Operation is subject to the following two conditions: (1) this device may not cause harmful interference, and (2) this device must accept any interference received, including interference that may cause undesired operation.

# USAGE NOTICE



**Warning** - To prevent the risk of fire or shock hazards, do not expose this product to rain or moisture.



**Warning** - Please do not open or disassemble the product as this may cause electric shock.

## Precautions

Follow all warnings, precautions and maintenance as recommended in this user's manual to maximize the life of your unit.

### **Do:**

- Turn off the product before cleaning.
- Touch screen surface may be cleaned using a soft clean cloth moistened with mild window glass commercial cleaners or 50/50 mixture of water and isopropyl alcohol.
- Use a soft cloth moistened with mild detergent to clean the display housing.
- Disconnect the power plug from AC outlet if the product is not going to be used for an extended period of time.

### **Don't:**

- Do not touch the LCD display screen surface with sharp or hard objects.
- Do not use abrasive cleaners, waxes or solvents for your cleaning.
- Do not operate the product under the following conditions:
  - Extremely hot, cold or humid environment.
  - Areas susceptible to excessive dust and dirt.
  - Near any appliance generating a strong magnetic field.
  - In direct sunlight.

TX-15, TX-17 & TX-19 is to be used as commercial and light industrial equipment only.

# CHAPTER 1: PRODUCT DESCRIPTION

## 1.1 Package Overview

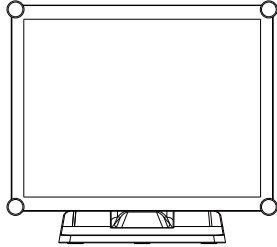

LCD Display

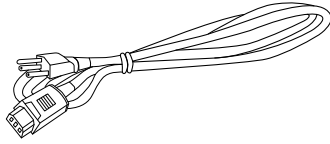

Power Cord

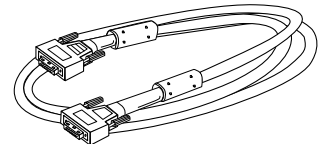

VGA Signal Cable

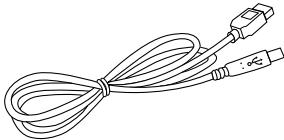

USB Cable (A to B)

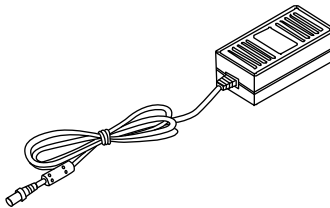

DC Power Supply

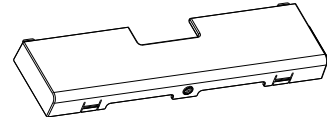

Cable Cover

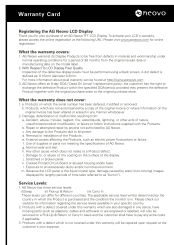

Warranty card



Cable Cover Screw  
(M3x6mm)

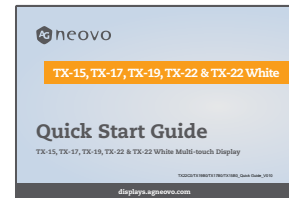

Quick Start Guide

# CHAPTER 2: INSTALLATION

## 2.1 Product Overview

### 2.1.1 Front View

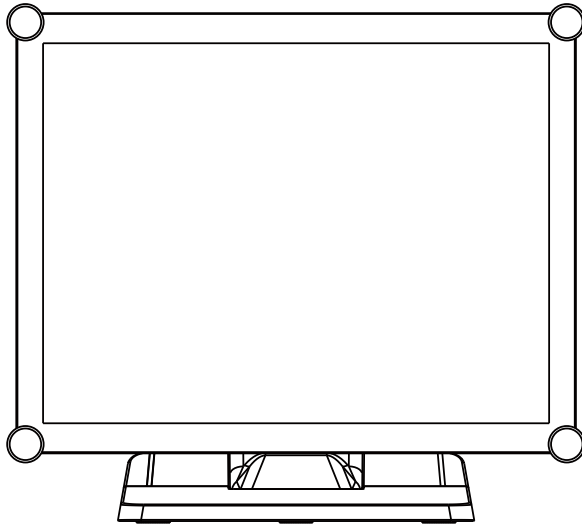

### 2.1.2 Bottom View (Without Stand)

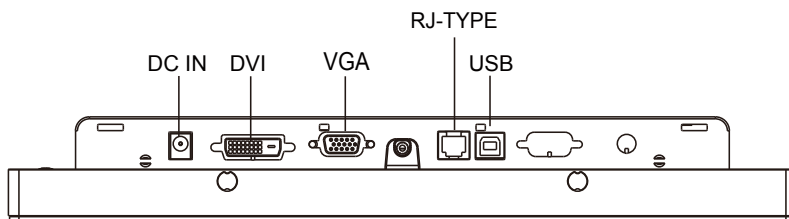

# INSTALLATION

## 2.2 Kensington Security Slot

The monitor can be secured to your desk or any other fixed object with Kensington lock security products. The Kensington lock is not included.

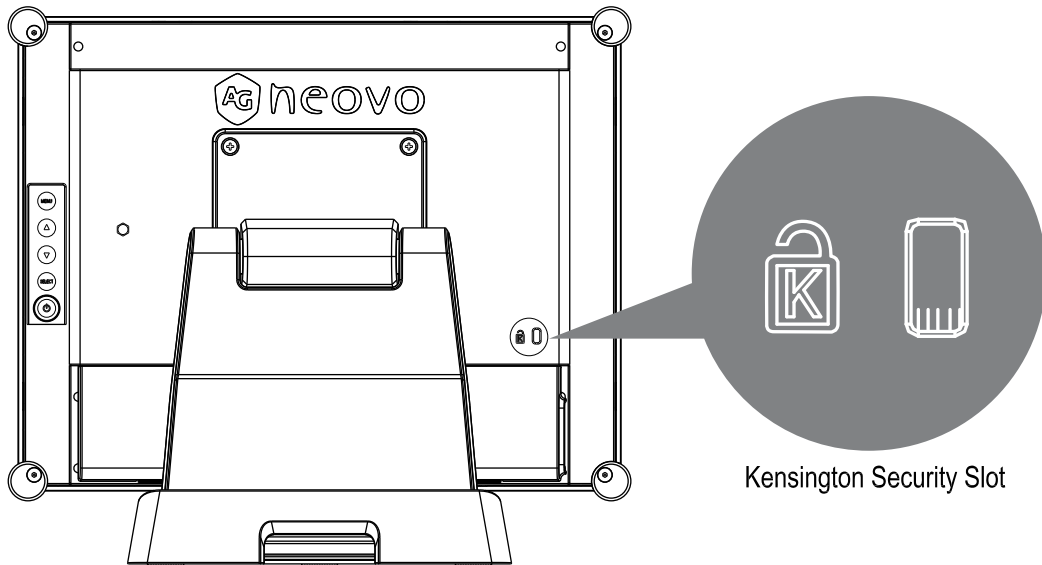



# INSTALLATION

## 2.3 VESA Mount for Your Monitor

This monitor conforms to the VESA Flat Panel Mounting Physical Mounting Interface standard which defines a physical mounting interface for flat panel monitors, and corresponding with the standards of flat panel monitor mounting devices, such as wall and table arms. The VESA mounting interface is located on the back of your monitor.

To mount the monitor on a UL certified swing arm or other mounting fixture, follow the instructions included with the mounting fixture to be used.

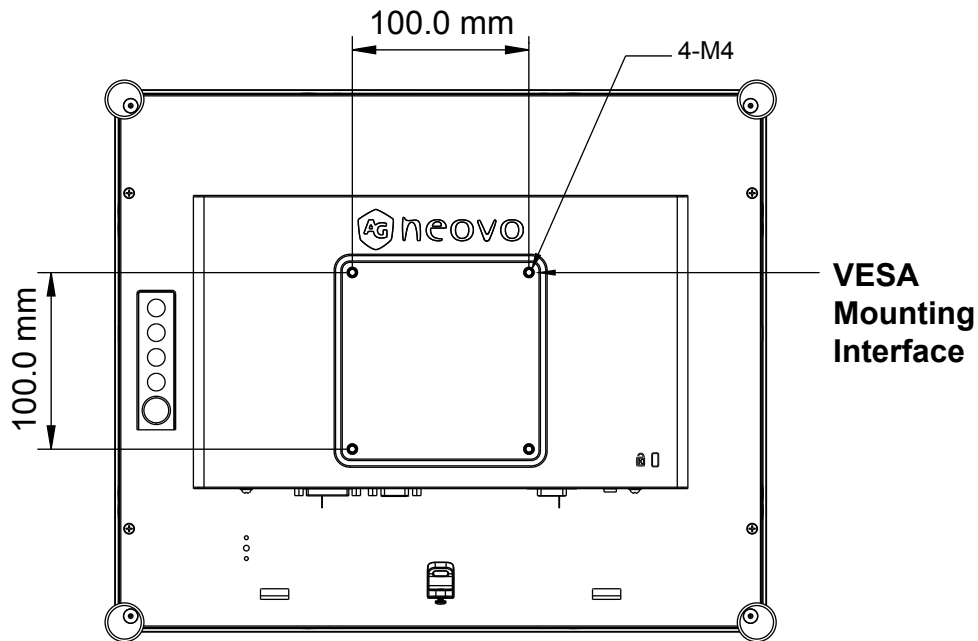

### **⚠ Warning!**

***Please select the proper screws!***

***The distance between the back cover surface and the bottom of the screw hole is 7 mm. Please use four M4 screws diameter with proper length to mount your monitor.***

***Please note: the mounting stand must be able to support at least TX-15: 13.7 lbs (6.2 Kg) / TX-17: 17.0 lbs (7.7 Kg) / TX-19: 18.7 lbs (8.5 Kg).***

# INSTALLATION

## 2.4 Start Your Installation

Please follow these instructions so that you can hook up the cables to associated connectors.

1. Lay the LCD flat on an even surface.
2. Move the stand into position as seen in the step 2 diagram.
3. Remove the cable cover as seen in the step 3 diagram.
4. Connect the cables to the appropriate connectors as seen in the step 4 diagram.
5. Position all cables under the cover lip as seen in the step 5 diagram.
6. Re-attach the cable cover. Take the screw (M3x6mm) from the accessory box, and insert the screw into the cable cover and monitor as seen in the step 5 diagram.

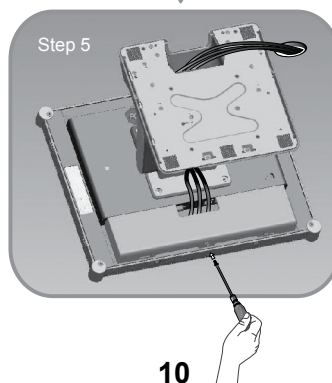
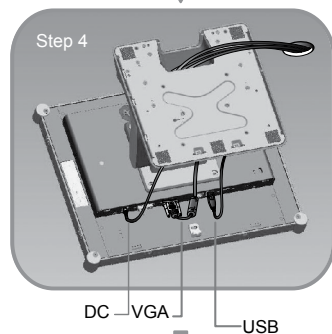
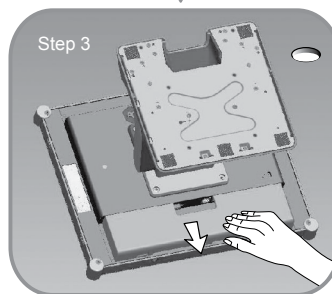
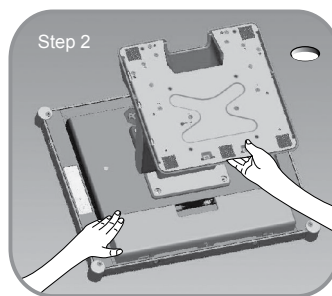

# INSTALLATION

## 2.5 Connecting the Display

To setup this display, please refer to the following figure and procedures.

1. Be sure all equipment is turned off.
2. Connect the DC adapter to the power connector on the monitor and the other end into an electrical outlet.
3. Connect the D-SUB or DVI cable from the display's D-SUB or DVI input connector to the D-SUB or DVI connector of your host computer and tighten the screws.
4. Connect the USB cable from the USB port of your display to the USB port of your computer.
5. Configure the touch screen. Refer to the "4.5 Touch Screen Driver Installation" section on page 25.
6. Once the touch screen is configured, the monitor is ready for use.

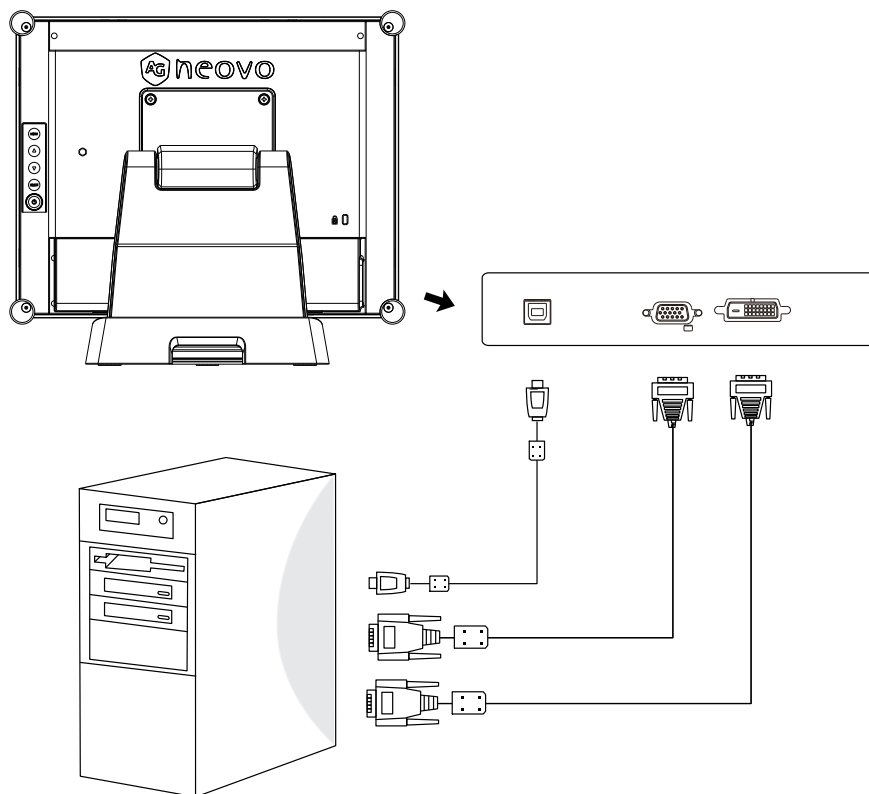

### **⚠ Notice!**

*To ensure the LCD display works well with your computer, please configure the display mode of your graphics card to make it less than or equal to 1024 x 768 resolution and make sure the timing of the display mode is compatible with the LCD display.*

*We have listed the compatible "Video Modes" of your LCD display in the appendix (on page 22~24) for your reference.*

*Don't connect telephone or internet cable to RJ-Type port.  
Adapter rating: 12Vdc 2.5A min., marked with LPS.*

# INSTALLATION



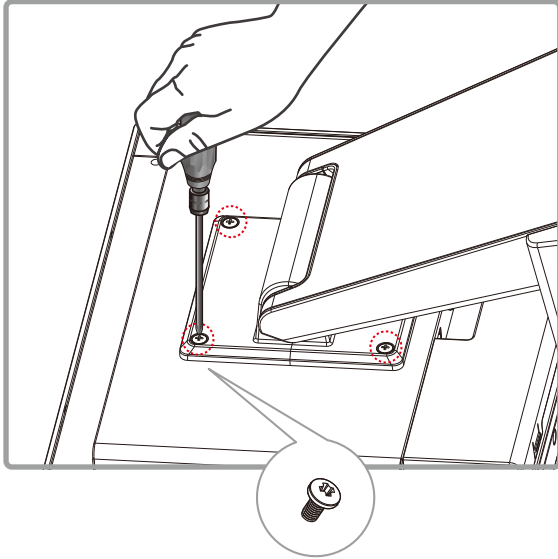

## 2.6 Remove the Deskstand



Remove 4 screws and then remove stand.

# CHAPTER 3: USER CONTROLS

## 3.1 Back Panel Controls



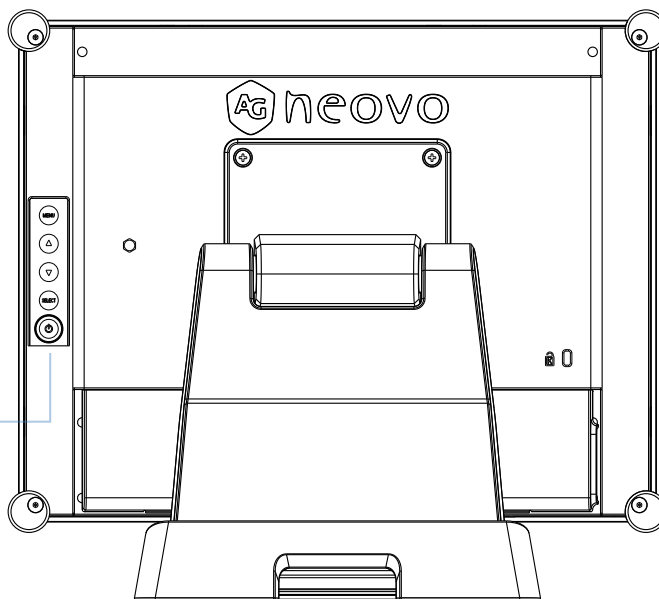

Icon	Key Name
	Menu
	Up
	Down
	Enter
	Power



OSD Key	Menu off status	Menu on status
MENU	Menu appear	Menu disappear / return to main item
▲	Brightness	Main item select up / Adjust up
▼	Contrast	Main item select down / Adjust down
Select	Enter / Select sub-item function	
⏻	Power On / Off	

# USER CONTROLS

## 3.2 How to Use the OSD Menu

Icon	Key Name
	Menu
	Up
	Down
	Enter
	Power

1. Press the “Menu” button to pop up the “on-screen menu” and press “Up” or “Down” button to select among the five functions in the main menu.
2. Choose the adjustment items by pressing the “Enter” button.
3. Adjust the value of the adjustment items by pressing the “Up” or “Down” button.
4. With the OSD menu on the screen, press the “Menu” button to return to the main menu or to exit OSD.
5. The OSD menu will automatically close, if you have left it idle for a pre-set time.
6. To Lock the OSD / Power menu buttons, please follow the instructions below.  
(Please note: the monitor has to be turned ON with a valid signal pre-set)
  - (a.) Press the “Menu” key; the OSD menu will pop upon display.
  - (b.) Press and hold the “Menu” key again with the OSD menu on the screen; the OSD menu will disappear. Then press the “Power” key 1 time while the menu key is still being pressed. The “Lock/Unlock” menu will appear for 3 seconds.
  - (c.) Use the “Enter” key to select OSD or Power setting then set at “Lock” by pushing the “UP” or “Down” button.
  - (d.) When the “UP” or “Down” button is released, the previous setting will be saved and exit the “Lock/Unlock” menu automatically.
7. To Unlock the OSD / Power menu buttons, please follow the instructions below.  
(Please note: the monitor has to be turned ON with a valid signal pre-set)
  - (a.) Press and hold the “Menu” key then press the “Power” key simultaneously; the “Lock/Unlock” menu will appear for 3 seconds.
  - (b.) Use the “Enter” key to select OSD or Power setting then set at “Unlock” by pushing the “UP” or “Down” button.
  - (c.) When the “Up” or “Down” button is released, the previous setting will be saved, and exit the “Lock/Unlock” menu automatically.

**Please note:**

- a. When the OSD Lock function is selected, this indicates that all the buttons except the “power” button are now disabled.
- b. When the Power Lock function is selected, this indicates that the “Power” key is disabled; user cannot turn off the monitor by “Power” key.

# USER CONTROLS

## 3.3 On-Screen Display Menus

### Main OSD Menu:

ITEM	CONTENT
<b>Contrast</b>	The monitor luminance level control.
<b>Brightness</b>	The monitor backlight level control.
<b>Auto Adjust</b>	Fine-tune the image to full screen automatically.
<b>Left/Right</b>	Moving screen image horizontal position to left or right.
<b>Up/Down</b>	Moving screen image vertical position to up or down.
<b>Horizontal size</b>	The screen image horizontal dot clock adjustment.
<b>Fine</b>	The screen image pixel phase adjustment.
<b>OSD Left/Right</b>	Moving OSD menu horizontal position to left or right.
<b>OSD Up/Down</b>	Moving OSD menu vertical position to up or down.
<b>OSD Time out</b>	OSD auto-disappear time selection.
<b>OSD Language</b>	OSD menu language selection. ( English, French, Japanese, Deutsch, Spanish, Italian, Traditional Chinese and Simplified Chinese)
<b>Factory Reset</b>	Factory default value restored.
<b>RGB</b>	Color temperature selection. (9300K, 6500K, 5500K, 7500K, User)

# CHAPTER 4: APPENDIX

## 4.1 Troubleshooting

If you are experiencing trouble with the LCD display, refer to the following. If the problem persists, please contact your local dealer or our service center.

***Problem: No image appears on screen.***

- ▶ Check that all the I/O and power connectors are correctly and well connected as described in the “Installation” section.
- ▶ Make sure the pins of the connectors are not crooked or broken.

***Problem: Partial image or incorrectly displayed image.***

- ▶ Check to see if the resolution of your computer is higher than that of the LCD display.
- ▶ Reconfigure the resolution of your computer to make it less than or equal to 1024 x 768 (TX-15), 1280 x 1024 (TX-17, TX-19).

***Problem: Image has vertical flickering line bars.***

- ▶ Use “Fine” to make an adjustment.
- ▶ Check and reconfigure the display mode of the vertical refresh rate of your graphic card to make it compatible with the LCD display.

***Problem: Image is unstable and flickering***

- ▶ Use “Fine” to make an adjustment.

***Problem: Image is scrolling***

- ▶ Check and make sure the VGA signal cable (or adapter) is securely connected.
- ▶ Check and reconfigure the display mode of the vertical refresh rate of your graphics card to make it compatible with the LCD display.

***Problem: Vague image (characters and graphics)***

- ▶ Use “Fine” to make an adjustment. If this problem persists, use “Horizontal size” to make an adjustment.



## 4.2 Warning Signal

If you see warning messages on your LCD screen, this means that the LCD display cannot receive a clean signal from the computer graphics card.

Below are the three kinds of Warning Signal. Please check the cable connections or contact your local dealer or our service center for more information.

### 4.2.1 No Signal

This message means that the LCD display has been powered on but it cannot receive any signal from the computer graphics card. Check all the power switches, power cables, and VGA/DVI signal cable.

### 4.2.2 Going to Sleep

The LCD display is under the power saving mode. In addition, the LCD display will enter power saving mode when experiencing a sudden signal disconnecting problem.

The monitor can be activated by pressing any keyboard, triggering the mouse or touching the screen.

### 4.2.3 Out of Range

This message means that the signal of the computer graphic card is not compatible with the LCD display. When the signal is not included in the "Video Modes" list we have listed in the Appendices of this manual, the LCD monitor will display this message.



# APPENDIX

## TX-17

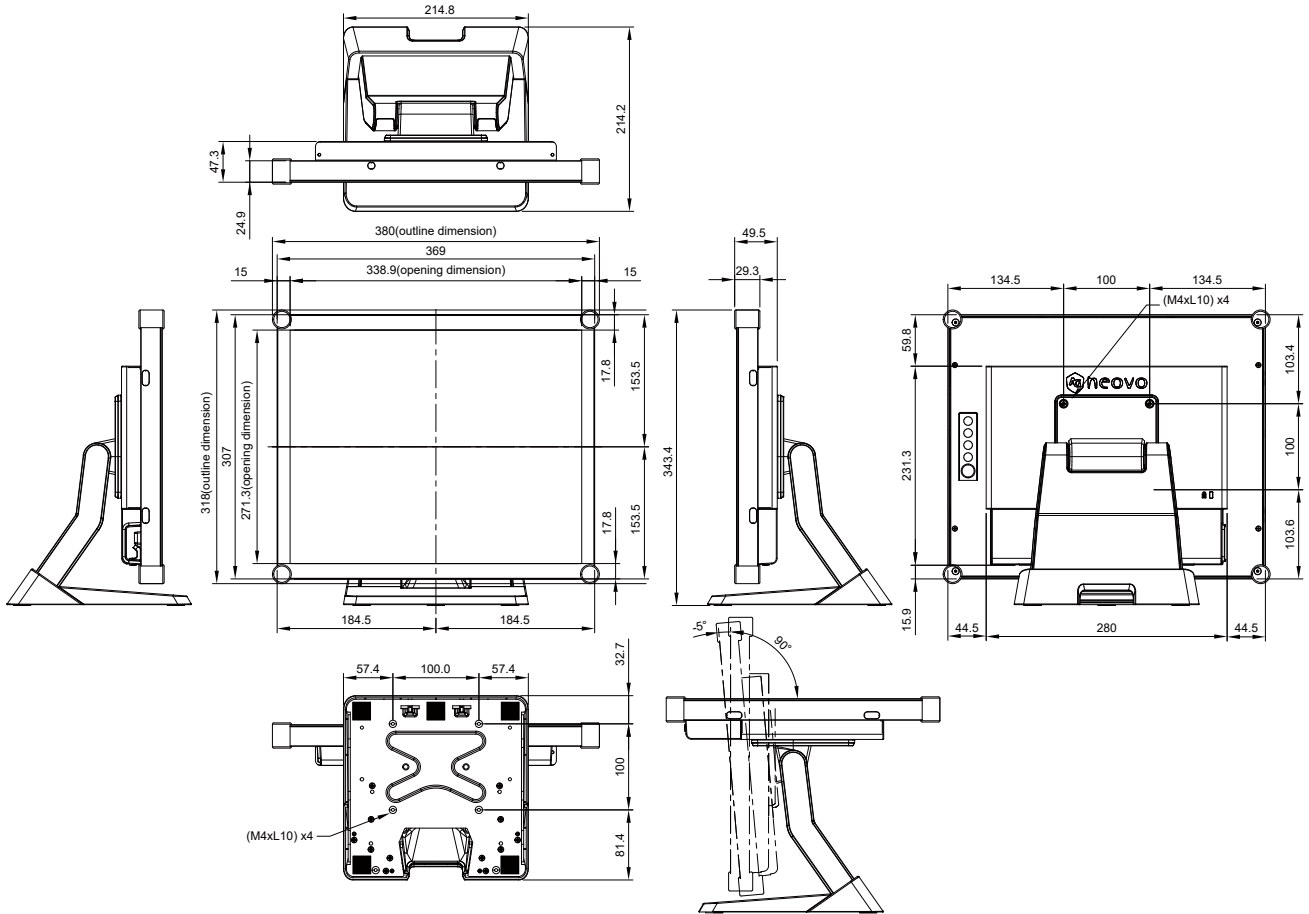

# APPENDIX

## TX-19

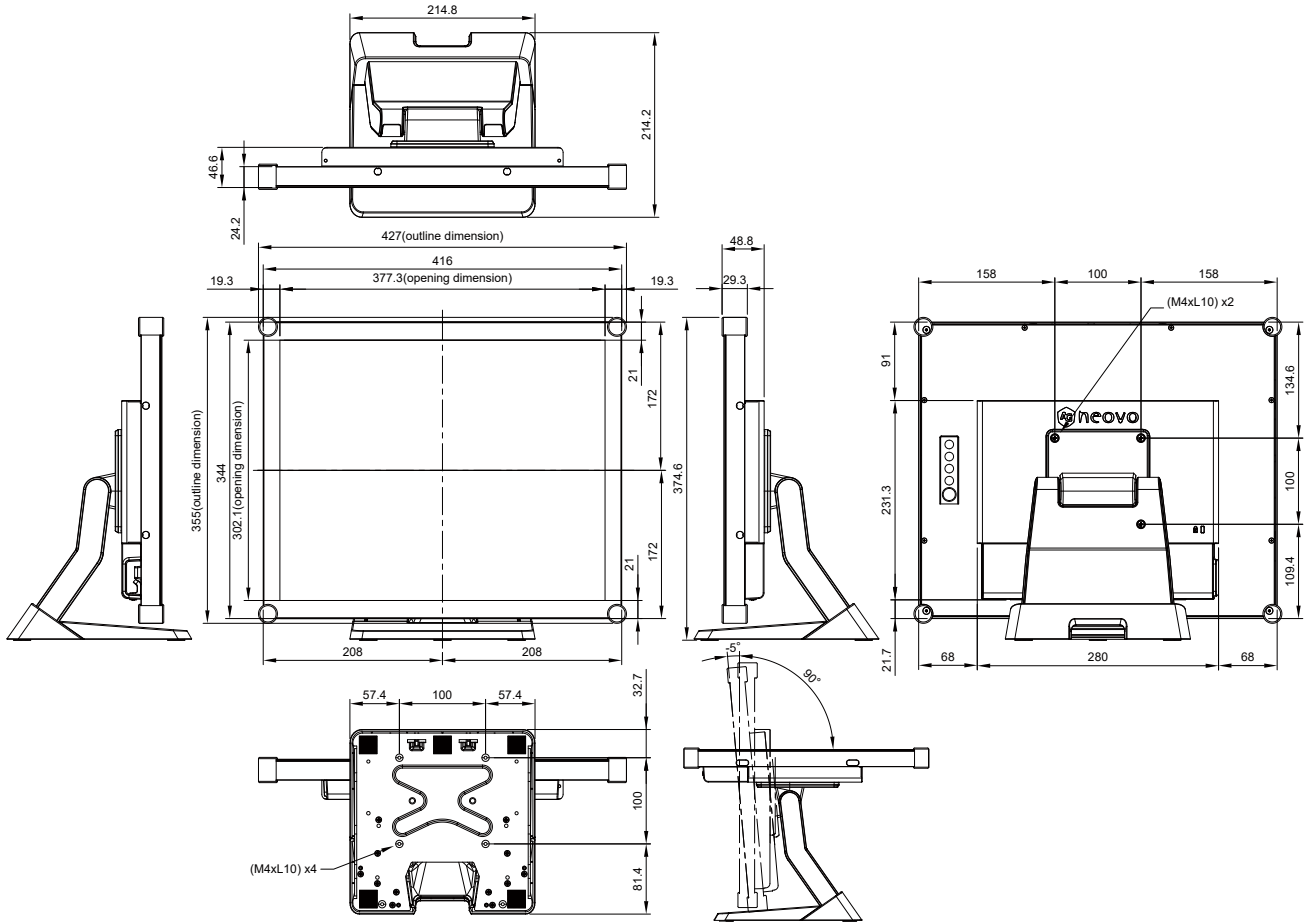

# APPENDIX

## 4.4 Compatibility Modes

### TX-15

Mode	Resolution	H-Frequency(khz)	V-Frequency(hz)
IBM VGA	720X400	31.47	70
IBM VGA	640X480	31.47	60
Apple MacII	640X480	35.00	66
VESA VGA	640X480	37.86	72
VESA VGA	640X480	37.50	75
VESA SVGA	800X600	35.16	56
VESA SVGA	800X600	37.88	60
VESA SVGA	800X600	48.08	72
VESA SVGA	800X600	46.88	75
Apple Mac	832X624	49.72	75
VESA XGA	1024X768	48.36	60
VESA XGA	1024X768	56.48	70
VESA XGA	1024X768	60.02	75

# APPENDIX

## TX-17

Mode	Resolution	H-Frequency(khz)	V-Frequency(hz)
IBM VGA	720X400	31.47	70
IBM VGA	640X480	31.47	60
Apple MacII	640X480	35.00	66
VESA VGA	640X480	37.86	72
VESA VGA	640X480	37.50	75
VESA SVGA	800X600	35.16	56
VESA SVGA	800X600	37.88	60
VESA SVGA	800X600	48.08	72
VESA SVGA	800X600	46.88	75
Apple Mac	832X624	49.72	75
VESA XGA	1024X768	48.36	60
VESA XGA	1024X768	56.48	70
VESA XGA	1024X768	60.02	75
VESA SXGA	1280X1024	64	60
VESA SXGA	1280X1024	80	75
VESA SXGA	1152X864	67.5	75
VESA SXGA	1280X960	60	60

# APPENDIX

## TX-19

Mode	Resolution	H-Frequency(khz)	V-Frequency(hz)
IBM VGA	720X400	31.47	70
IBM VGA	640X480	31.47	60
Apple MacII	640X480	35.00	66
VESA VGA	640X480	37.86	72
VESA VGA	640X480	37.50	75
VESA SVGA	800X600	35.16	56
VESA SVGA	800X600	37.88	60
VESA SVGA	800X600	48.08	72
VESA SVGA	800X600	46.88	75
Apple Mac	832X624	49.72	75
VESA XGA	1024X768	48.36	60
VESA XGA	1024X768	56.48	70
VESA XGA	1024X768	60.02	75
VESA SXGA	1280X1024	64	60
VESA SXGA	1280X1024	80	75
VESA SXGA	1152X864	67.5	75
VESA SXGA	1280X960	60	60

# APPENDIX

## 4.5 Touch Screen Driver Installation

The TX-15, TX-17 & TX-19 is available with USB connections. The touch driver can be downloaded in the “www.agneovo.com” website for these operating systems: Windows® 7/8/10, VISTA, XP, 2000, CE, XP Embedded, Apple® Mac OS, Linux (Up to 5 points), Android 2.1 upward and 4.0 as well (Up to 10 points). (Windows 7/8/10 Multi touch without driver).

### Please Note:

1. The TX-15, TX-17 & TX-19 are Microsoft® Windows® HID (Human Interface Device) compatible if you use the USB touch screen interface. No additional software driver is required for general operation of the touch screen. A calibration tool can be installed for improved touch position accuracy. See “Optional Calibration Tool Install” section for more information.
2. For TX-15, TX-17 & TX-19, the system requires 15 seconds for Windows 7/8/10 to install/uninstall the touch drivers while turning power on/off or plugging/unplugging USB cable.

### 4.5.1 Optional Calibration Tool Install

Calibrating the touch screen in Windows 7/8/10:

1. Tap the Start button, Control Panel and then Hardware and Sound.
2. Under Tablet PC Settings, tap Calibrate the screen for pen or touch input.
3. On the Display tab, under Display options, tap Calibrate and then Yes to allow the program to make changes.
4. Follow the on-screen instructions to calibrate the touch screen.

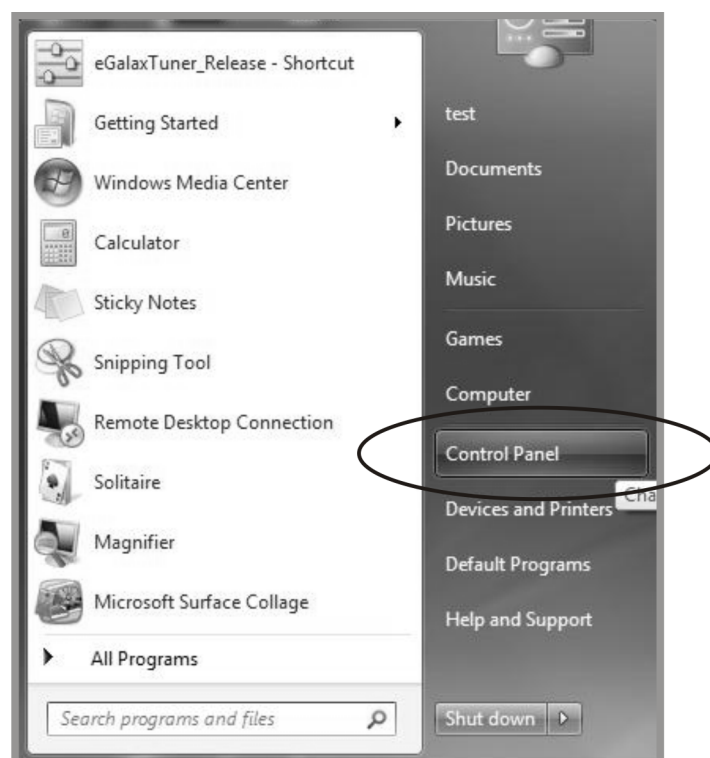



# APPENDIX

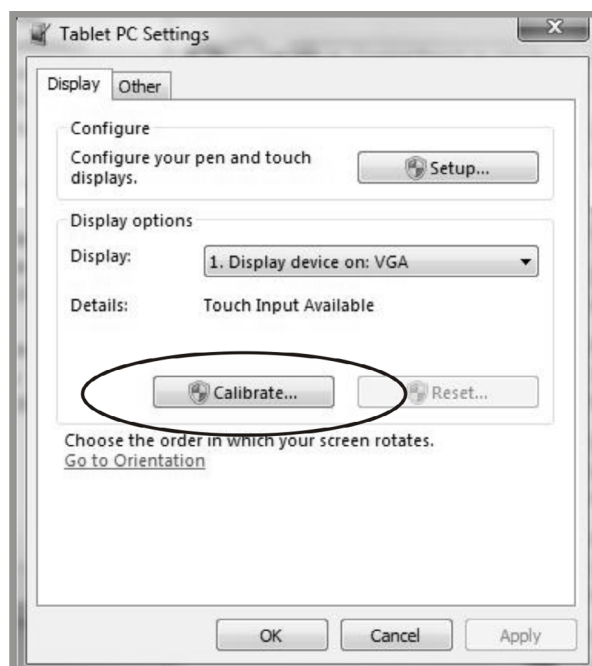
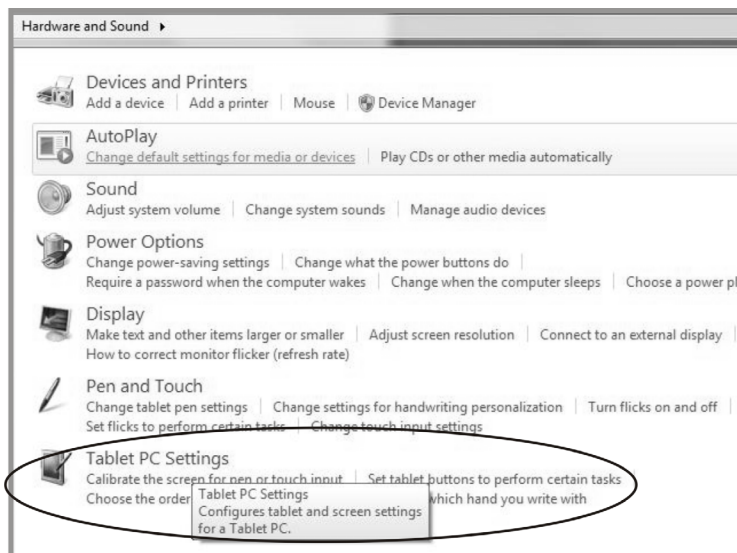
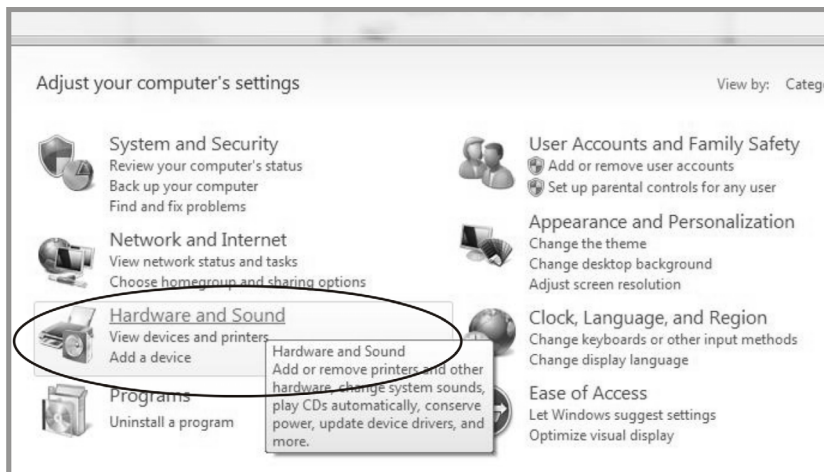

# APPENDIX

## 4.5.2 Driver Install Instructions

**If you are using a PC running Windows VISTA, XP, 2000, follow the instructions below:**

1. Power on the PC.
2. Be sure the USB cable is connected from the PC to the LCD display.
3. Open the corresponding driver folder file.
4. Follow the step-by-step instructions as shown on the pop-up windows.

**If you are using a PC running Windows® XP Embedded, follow the instructions below:**

**Express:**

1. Power on the computer.
2. Make sure that the USB cable is connected to the computer.
3. Be sure that your EWF is disabled. If your EWF is enabled, please disable the EWF by using the EWF Manager command.
4. Once the EWF is disabled click on the XP driver and follow the step-by-step instructions as shown on the pop-up windows.

**Custom:**

1. Power on the computer.
2. Make sure that the USB cable is connected to the computer.
3. Follow the step-by-step instructions found in the driver folder file.

**If you are using a PC running Windows® CE, follow the instructions below:**

1. Power on the computer.
2. Make sure that the USB cable is connected to the computer.
3. Using Platform Builder, build an image file by following the step-by-step instructions found in the driver folder file.

**If you are using a PC running Linux (Up to 5 points) or Android 2.1 upward and 4.0 as well (Up to 10 points) or Apple® Mac OS, follow the instructions below:**

1. Power on the computer.
2. Make sure that the USB cable is connected to the computer.
3. Follow the step-by-step instructions found in the driver folder file.

# CHAPTER 5: SPECIFICATIONS

## 5.1 Display Specifications

		TX-15	TX-17	TX-19
Panel	Panel Type	LED-Backlit TFT LCD (VA Technology)	LED-Backlit TFT LCD (VA Technology)	LED-Backlit TFT LCD (IPS Technology)
	Panel Size	15.0"	17.0"	18.9"
	Max. Resolution	XGA 1024 x 768	SXGA 1280 x 1024	SXGA 1280 x 1024
	Pixel Pitch	0.297 mm	0.264 mm	0.293 mm
	Brightness	350 cd/m <sup>2</sup>	250 cd/m <sup>2</sup>	250 cd/m <sup>2</sup>
	Contrast Ratio	800:1	1000:1	1000:1
	Viewing Angle (H/V)	160°/150°	170°/160°	178°/178°
	Display Colour	16.2M	16.7M	16.7M
	Response Time	5 ms	3 ms	5 ms
	Surface Treatment	Anti-Glare Treatment (Haze 25%), 3H Hard Coating	Anti-Glare Treatment (Haze 25%), 3H Hard Coating	Anti-Glare Treatment (Haze 25%), 3H Hard Coating
Frequency (H/V)	H Freq.	31 kHz-60 kHz	31 kHz-80 kHz	31 kHz-80 kHz
	V Freq.	55 Hz-75 Hz	50 Hz-75 Hz	50 Hz-75 Hz
Input	DVI	24-Pin DVI-D x 1	24-Pin DVI-D x 1	24-Pin DVI-D x 1
	VGA	15-Pin D-Sub x 1	15-Pin D-Sub x 1	15-Pin D-Sub x 1
External Control	RJ11	Yes	Yes	Yes
Touch Screen	Technology	Projective Capacitive	Projective Capacitive	Projective Capacitive
	Positional Accuracy	± 2.0 mm	± 2.5 mm	± 2.5 mm
	Panel Interface	USB (Type-B)	USB (Type-B)	USB (Type-B)
	Multi-touch Plug & Play	10-point touch for Windows 7/8/10	10-point touch for Windows 7/8/10	10-point touch for Windows 7/8/10
	Single Touch Support by Driver	Windows VISTA/XP/2000/CE/XP Embedded, Mac OS	Windows VISTA/XP/2000/CE/XP Embedded, Mac OS	Windows VISTA/XP/2000/CE/XP Embedded, Mac OS
	Multi-touch Support by Driver	Linux (Up to 5 points) Android 2.1 upward and 4.0 as well (Up to 10 points)	Linux (Up to 5 points) Android 2.1 upward and 4.0 as well (Up to 10 points)	Linux (Up to 5 points) Android 2.1 upward and 4.0 as well (Up to 10 points)
Power	Power Supply	External	External	External
	Power Requirements	DC 12V, 2.5A	DC 12V, 2.5A	DC 12V, 2.5A
	On Mode	10W (On)	12W (On)	19W (On)
	Stand-by Mode	< 2W	< 2W	< 2W
	Off Mode	< 1W	< 1W	< 1W
Glass	Thickness	3.1 mm (0.12")	3.1 mm (0.12")	3.1 mm (0.12")
	Transmission Rate	> 90%	> 90%	> 90%
	Hardness	> 7H	> 7H	> 7H
Operating Conditions	Temperature	0°C-40°C (32°F-104°F)	0°C-40°C (32°F-104°F)	0°C-40°C (32°F-104°F)
	Humidity	20%-80% (non-condensing)	20%-80% (non-condensing)	20%-80% (non-condensing)
Storage Conditions	Temperature	-20°C-60°C (-4°F-140°F)	-20°C-60°C (-4°F-140°F)	-20°C-60°C (-4°F-140°F)
	Humidity	10%-90% (non-condensing)	10%-90% (non-condensing)	10%-90% (non-condensing)
Mounting	VESA FPMPMI	Yes (100 x 100 mm)	Yes (100 x 100 mm)	Yes (100 x 100 mm)
Stand	Tilt	-5° to 90°	-5° to 90°	-5° to 90°
Security	Kensington Security Slot	Yes	Yes	Yes

# SPECIFICATIONS

		TX-15	TX-17	TX-19
Dimensions	Product with Base (W x H x D)	348.4 x 312.7 x 214.2 mm (13.7" x 12.3" x 8.4")	380.0 x 343.4 x 214.2 mm (15.0" x 13.5" x 8.4")	427.0 x 374.6 x 214.2 mm (16.8" x 14.7" x 8.4")
	Packaging (W x H x D)	415.0 x 370.0 x 290.0 mm (16.3" x 14.6" x 11.4")	450.0 x 423.0 x 277.0 mm (17.7" x 16.7" x 10.9")	500.0 x 460.0 x 300.0 mm (19.7" x 18.1" x 11.8")
Weight	Product with Base	4.6 kg (10.1 lb)	5.8 kg (12.8 lb)	6.5 kg (14.3 lb)
	Packaging	7.0 kg (15.4 lb)	8.0 kg (17.6 lb)	8.3 kg (18.7 lb)

## Note:

- ◆ All specifications are subject to change without prior notice.

## AG Neovo

Company Address: 5F-1, No. 3-1, Park Street, Nangang District, Taipei, 11503, Taiwan.

Copyright © 2020 AG Neovo. All rights reserved.

TX19B0/TX17B0/TX15B0\_UM\_V012