

X-22E

NET WEIGHT: 6.9KG (with Stand)

6.3KG (w/o Stand)

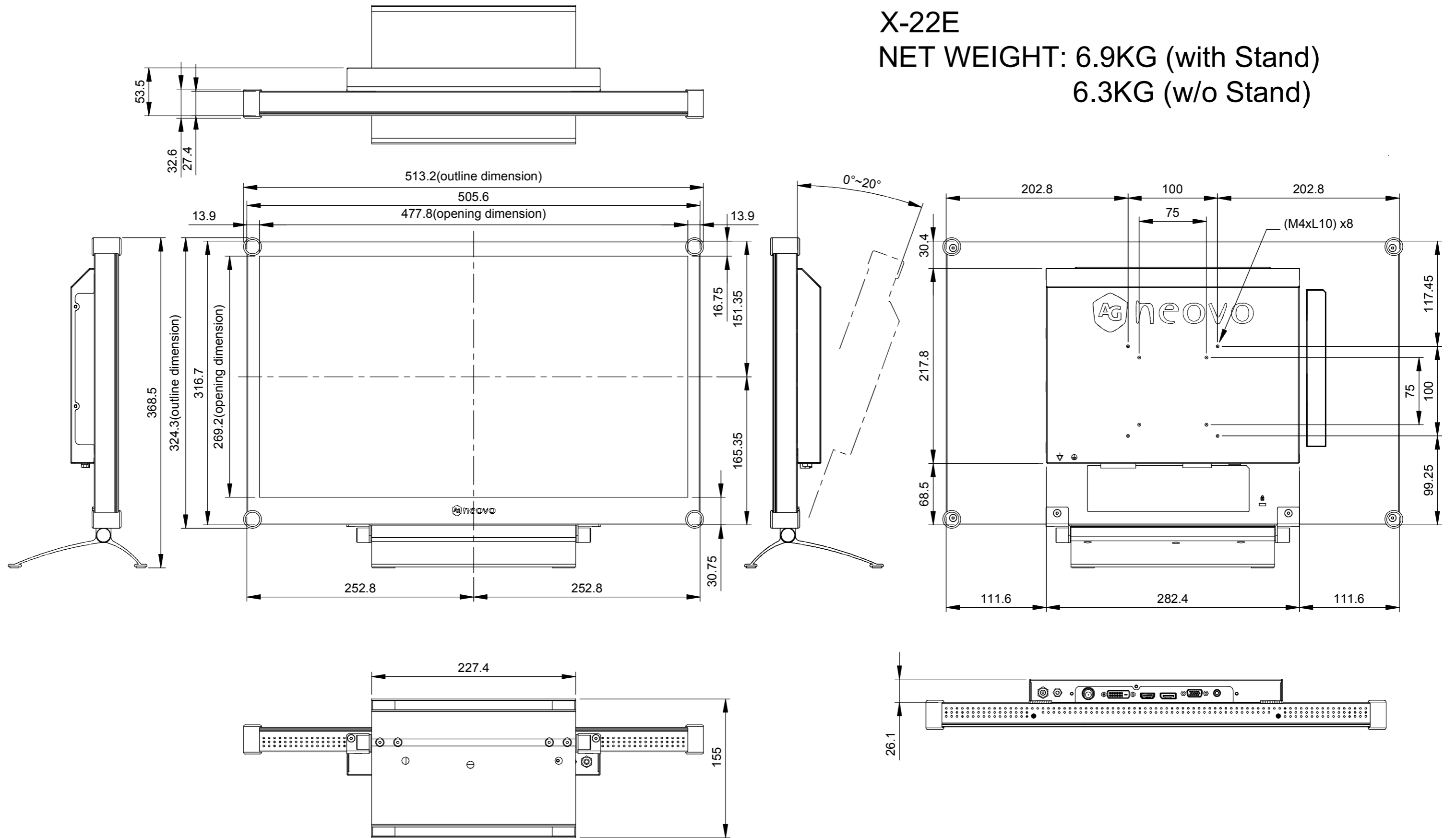

SPECIFICATIONS SUBJECT TO CHANGE WITHOUT NOTICE.



www.agneovo.com

Model Name:

X-22E

THIS DRAWING ON THIS PRINT AND INFORMATION BELONG WITH AG Neovo. ANY REPRODUCTION IN PART OR WHOLE WITHOUT WRITTEN PERMISSION OF AG Neovo IS PROHIBITED.



SCALE 1:1 UNITS MM V.01